

# U1000MKII FM

## Ultrasonic Flowmeter

### User Manual



Micronics Ltd, Knaves Beech Business Centre, Davies Way, Loudwater,  
High Wycombe, Bucks HP10 9QR

Telephone: +44(0)1628 810456

E-mail: [sales@micronicsltd.co.uk](mailto:sales@micronicsltd.co.uk)

[www.micronicsflowmeters.com](http://www.micronicsflowmeters.com)

## Contents

1	General Description.....	3
2	Quick start procedure.....	4
3	How does it work?.....	5
4	User interface.....	6
4.1	Key switches.....	6
5	Installing the U1000MKII-FM.....	7
5.1	Preparation.....	8
5.2	Sensor separation.....	8
5.3	Adaptors for small pipes.....	10
5.4	Attaching the U1000MKII-FM to the pipe.....	11
5.5	U1000MKII-FM Interface Cables.....	12
5.6	Connecting the U1000MKII-FM to the Supply.....	12
5.7	Pulse Output connection.....	13
5.8	Current Output (If fitted).....	13
5.9	ModbusConnections (if fitted).....	13
5.10	Cable Screen.....	14
6	Powering up for the first time.....	15
6.1	How to enter the Pipe ID.....	16
6.2	Pulse output.....	17
6.2.1	Volumetric mode.....	17
6.2.2	Frequency mode.....	17
6.2.3	Flow Alarm - High/Low Flow or Signal loss.....	18
6.3	4-20mA Current Output (if fitted).....	18
6.4	Modbus.....	19
7	Subsequent Power-ON Sequence.....	21
8	Password Controlled Menus.....	21
9	<i>General Procedure for changing menu settings</i> .....	21
9.1.1	<i>Selection menus</i> .....	21
9.1.2	<i>Data entry menus</i> .....	22
9.2	User Password controlled menu structure.....	22
10	Diagnostics Menu.....	28
11	Relocation of guide rail.....	29
12	Appendix I – U1000MKII-FM Specification.....	30
13	Appendix II – Default values.....	31
14	Appendix III – Error and Warning Messages.....	32
15	Declaration of Conformity.....	35

## 1 General Description

- Fixed installation, clamp-on flowmeter
- Easy to install
- Requires the minimum of information to be entered by the user
- Both the electronics and guide rail housings form an integral unit
- Simple attachment to the pipe using the supplied jubilee clips
- Power to the unit is provided by an external 12 - 24V ac/dc power supply (7VA minimum)
- Operates on steel, stainless steel, copper and plastic pipes with internal diameter in the range 20mm (0.8") to 165mm (6.5") depending on the product purchased.
- Compact, rugged and reliable, the U1000MK-FM has been designed to provide sustained performance in industrial environments

U1000MKII-FM standard features include:

- 2 line x 16 character LCD with backlight
- 4-key keypad
- Isolated pulse output
- Universal guide rail for setting pre-assembled transducers
- Two sets of self- adhesive Gel pad acoustic couplant
- Continuous signal monitoring
- Password protected menu operation for secure use
- Operates from external 12 to 24Vac or dc power supplies
- Small pipe adaptors

Options

- Pipe range
  - 20mm inside diameter to 114mm inside diameter pipe
  - 115mm inside diameter to 165mm inside diameter pipe
- 4-20mA current output
- Modbus output
- Pulse output is standard

Typical applications

- Hot water metering and flow measurement
- Flow measurement for Heat Metering
- Chilled water metering and flow measurement
- Potable water metering and flow measurement
- Process water metering and flow measurement
- Ultra-pure water metering and flow measurement.

## 2 Quick start procedure

The following procedure details the steps required to set up the flow meter. See the sections referred to if you are unsure about how to install the instrument.

1. Wire the electronics up to a 12 to 24V ac or dc power supply (7VA minimum per instrument) via the Blue and Brown wires. (See Section 5.6)
2. Establish a suitable location for the flow meter on a straight length of pipe clear of bends and valves or similar obstructions. (See Sections 5 and 5.1)
3. Determine the pipe internal diameter and material.
4. Either use the table in the manual, or power up the instrument to determine the correct separation code. (See Sections 5.2 or 6)
5. Set the sensors to the correct separation by adjusting the sensor holding screws so the sensor can slide in the slot. (See Section 5.2)
6. Select any adaptors needed for pipes with an **outside** diameter of less than 60mm, **inside** diameter will typically be less than 50mm. (See Section 5.3)
7. Apply the Gel pads or couplant to the sensors and mount the guide rail on the pipe using the banding provided, then remove the sensor holding screws. (See Section 5.4)
8. Plug in the flow sensors and **DO NOT** clip the electronics assembly on to the guide rail at this stage.
9. Power up the instrument and check that flow readings can be obtained (See Sections 6 and 7)
10. Once good readings have been obtained any further changes, such as selecting different units, can be made via the Password Controlled Menu. (See Section 8)
11. When happy with set up and readings, clip the electronic assembly to the guide rail, and tighten screw to complete assembly
12. If the Modbus interface is being used then the address, and data rate, and configuration of the instrument must be set using the modbus Menu. (See Section 6.4). The default address is 1, the default data rate is 38400 baud, and the default comms configuration is 8-None-2.

### 3 How does it work?

The U1000MKII-FM is a clamp-on, ultrasonic flowmeter that uses a cross correlation transit time algorithm to provide accurate flow measurements.

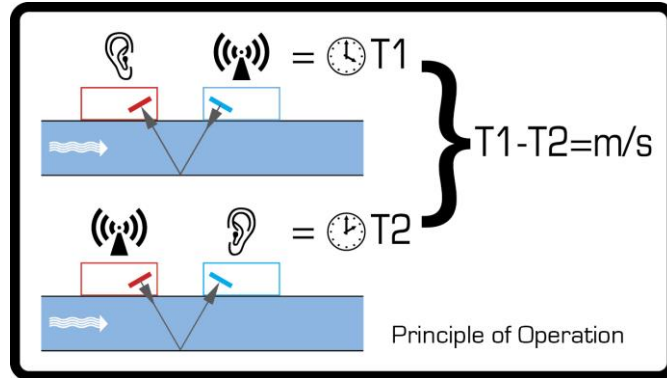

Figure 1 Principle of Transit-Time operation

An ultrasonic beam of a given frequency is generated by applying a repetitive voltage pulse to the transducer crystals. This transmission goes first from the Downstream (blue) transducer to the Upstream transducer (red) as shown in the upper half of Figure 1. The transmission is then made in the reverse direction, being sent from the Upstream transducer (red) to the Downstream transducer (blue) as shown in the lower half of Figure 1. The speed at which the ultrasound is transmitted through the liquid is accelerated slightly by the velocity of the liquid through the pipe. The subsequent time difference  $T1 - T2$  is directly proportional to the liquid flow velocity.

## 4 User interface

Figure 2 illustrates the U1000MKII-FM user interface comprising:-

- One 2 line x 16 character LCD with backlight
- Four tactile key switches
- Two LEDs



Figure 2 U1000MKII-FM User Interface

### 4.1 Key switches



Selection key. Allows the user to select between options on the display.



Used to increment the value of each digit in numeric entry fields.



Used to decrement the value of each digit in numeric entry fields.



Used to enter the selection displayed or terminate the data entry. Pressing this key will take the user to another menu or to the Flow Reading screen.



4-20mA LED is illuminated when the 4-20mA output is enabled.



Pulse LED is illuminated when the Pulse, Frequency or Alarm functions are enabled.

## 5 Installing the U1000MKII-FM

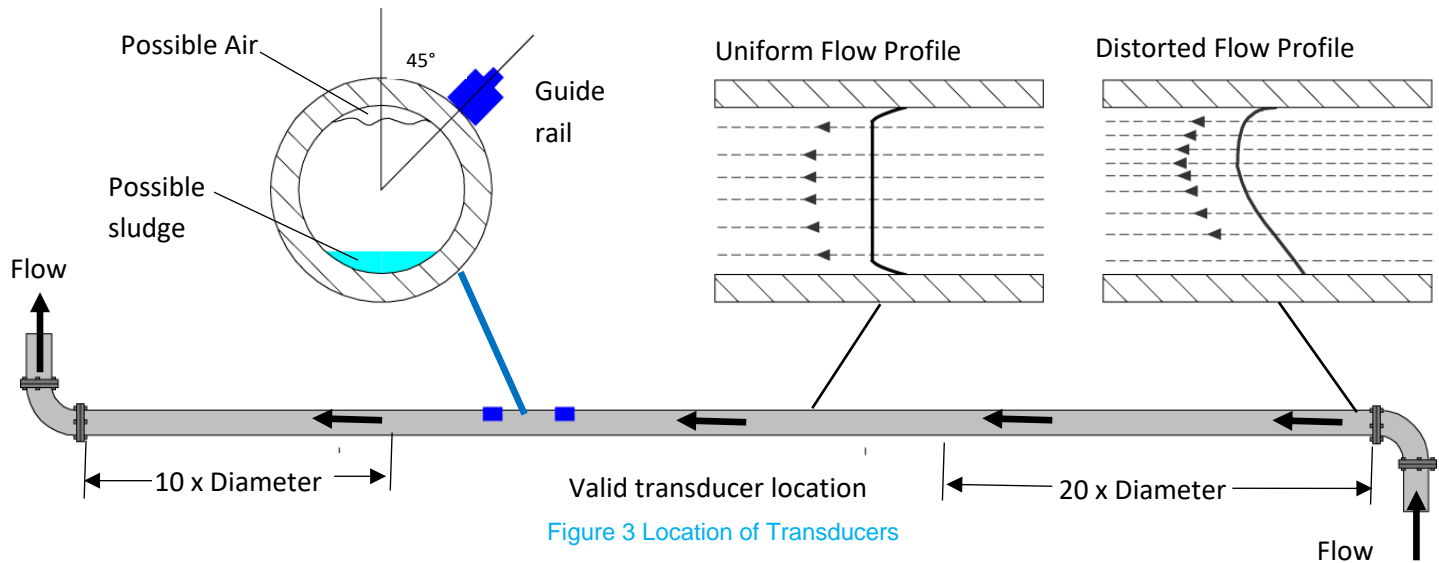

Figure 3 Location of Transducers

In many applications an even flow velocity profile over a full 360° is unattainable due, for example, to the presence of air turbulence at the top of the flow and also possibly sludge at the bottom of the pipe. Experience has shown that the most consistently accurate results are achieved when the transducer guide rails are mounted at 45° with respect to the top of the pipe.

The U1000MKII-FM equipment expects a uniform flow profile as a distorted flow will produce unpredictable measurement errors. Flow profile distortions can result from upstream disturbance such as bends, tees, valves, pumps and other similar obstructions. To ensure a uniform profile the transducers must be mounted far enough away from any cause of distortion such that it no longer has an effect.

To obtain the most accurate results the condition of both the liquid and the pipe must be suitable to allow ultrasound transmission along the predetermined path. It is important that liquid flows uniformly within the length of pipe being monitored, and that the flow profile is not distorted by any upstream or downstream obstructions. This is best achieved by ensuring there is a straight length of pipe upstream of the transducers of at least 20 times the pipe diameter, and 10 times the pipe diameter on the downstream side, as shown in Figure 3. Flow Measurements can be made on shorter lengths of straight pipe, down to 10 diameters upstream and 5 diameters downstream, but when the transducers are mounted this close to any obstruction the resulting errors can be unpredictable.

**Key Point:** Do not expect to obtain accurate results if the transducers are positioned close to any obstruction that distorts the uniformity of the flow profile.

Micronics Ltd accepts no responsibility or liability if product has not been installed in accordance with the installation instructions applicable to the product.

### 5.1 Preparation

1. Before attaching the transducers first ensure that the proposed location satisfies the distance requirements shown in Figure 3 otherwise the resulting accuracy of the flow readings may be affected.
2. Prepare the pipe by degreasing it and removing any loose material or flaking paint in order to obtain the best possible surface. A smooth contact between pipe surface and the face of the transducers is an important factor in achieving a good ultrasound signal strength and therefore maximum accuracy.

### 5.2 Sensor separation

Depending on what pipe range has been purchased the sensor must be positioned at the correct distance for the pipe size and type they will be used on. The table below gives the typical separation code for a given pipe material and inside diameter, using a pipe wall thickness algorithm. The instrument displays the required separation after the pipe internal diameter and material are entered.

Pipe ID	Pipe ID	Water	Glycol
mm	inches	S/Steel	S/Steel
20-22	0.79-0.87	A-3	A-3
26-29	1.02-1.14	B-2	B-2
34-36	1.34-1.42	C-2	C-4
37-40	1.46-1.57	B-3	D-4
52-58	2.05-2.29	B-2	D-3
59-64	2.32-2.52	A-3	F-3
72-79	2.83-3.11	B-3	E-5
86-92	3.39-3.62	C-3	B-4
99-105	3.90-4.13	D-3	C-4
125-131	4.92-5.16	F-3	E-4
152-158	5.98-6.22	E-5	G-4

PipeID	Pipe ID	Water	Glycol
mm	inches	M/Steel	M/Steel
21-22	0.83-0.87	C-3	C-3
27	1.06	D-2	E-3
35-36	1.38-1.42	C-4	C-4
41-44	1.61-1.73	C-3	F-3
52-54	2.05-2.13	C-4	C-4
62-65	2.44-2.56	F-3	F-3
76-79	2.99-3.11	E-5	G-4
88-94	3.46-3.70	B-4	B-4
95-101	3.74-3.98	D-3	C-4
122-128	4.80-5.04	F-3	E-4
150-156	5.90-6.14	E-5	G-4

Pipe ID	Pipe ID	Water	Glycol
mm	inches	PVC U	PVC U
22-23	0.87-0.90	C-3	C-3
27-28	1.06-1.10	D-2	C-3
36-37	1.42-1.45	C-4	C-4
43-45	1.69-1.77	C-3	B-4
56-59	2.20-2.32	E-3	E-3
67-69	2.64-2.71	E-4	D-5
78-81	3.07-3.19	D-2	C-3
95-101	3.74-3.97	D-3	C-4
109-115	4.29-4.53	E-3	D-4
122-128	4.80-5.04	F-3	E-4
143-149	5.63-5.87	F-4	E-5
157-162	6.18-6.34	G-4	F-5

Pipe ID	Pipe ID	Water	Glycol
mm	inches	Copper	Copper
20-39	0.79-1.54	B-1	B-1
20-39	0.79-1.54	B-1	B-1
20-39	0.79-1.54	B-1	B-1
20-39	0.79-1.54	B-1	A-2
47-53	1.85-2.09	C-1	C-1
61-67	2.40-2.64	A-3	A-3
68-74	2.68-2.91	C-2	B-3
96-102	3.78-4.02	B-4	B-4
117-123	4.61-4.84	E-3	D-4
146-152	5.75-5.98	D-5	D-5

Figure 4 Separation Table



The diagram below shows how to adjust the separation of the sensors

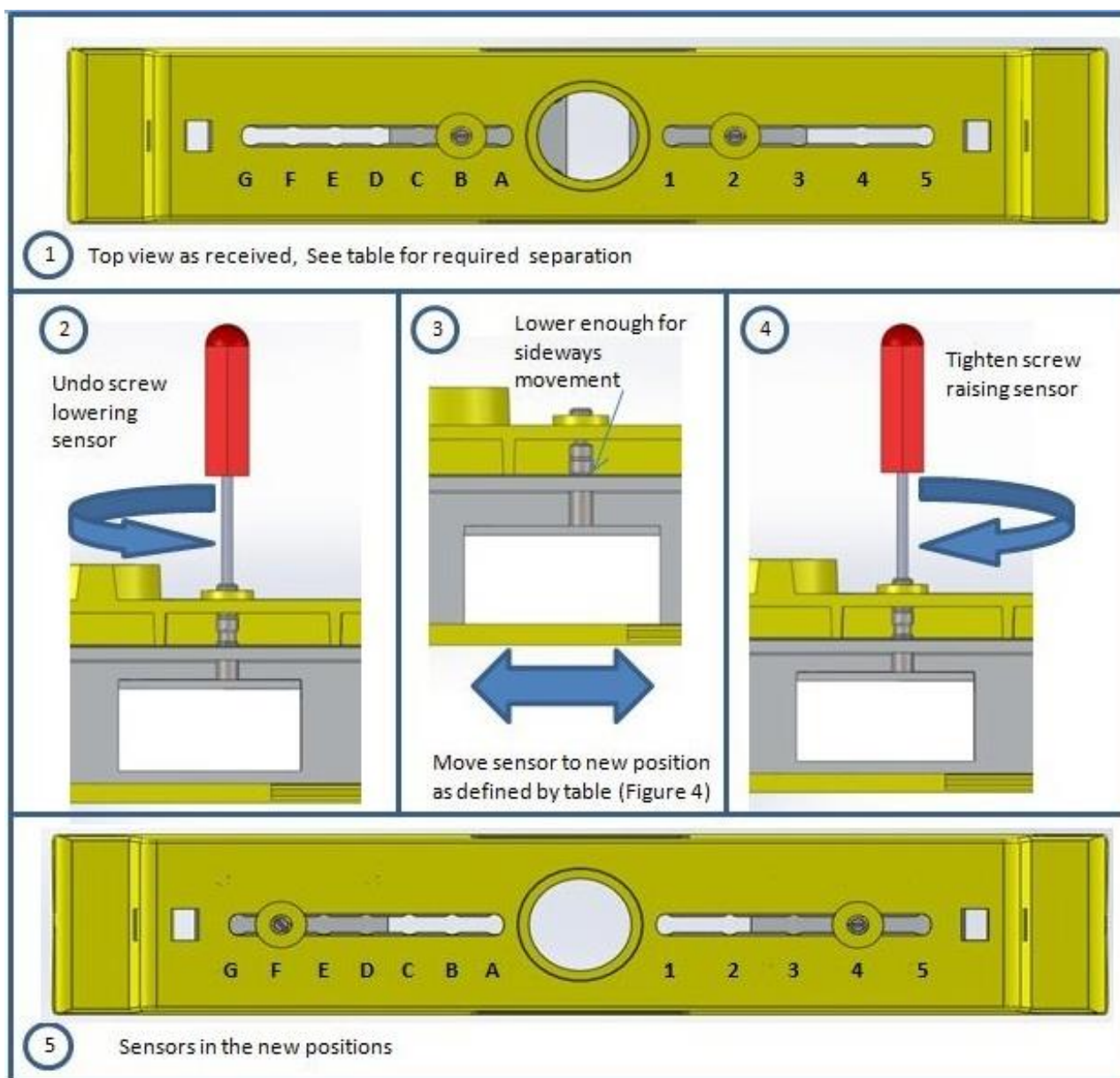
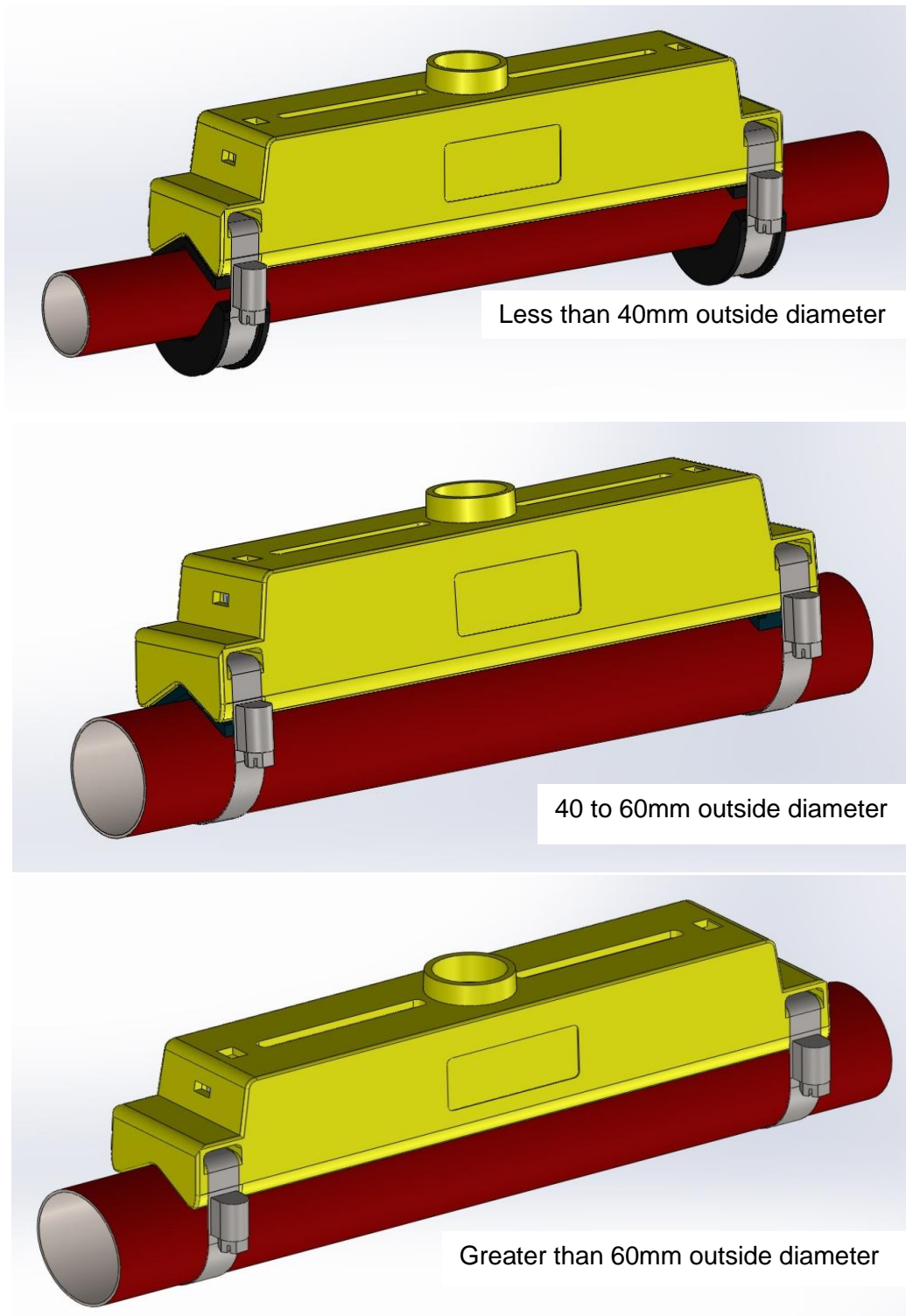

Figure 5 Separation Setting

**NOTE. When the sensors have been moved to the correct setting and the guide rail is attached to the pipe REMOVE the sensor holding screws, which will allow the spring loaded transducers to make contact with the pipe.**

### 5.3 Adaptors for small pipes



**Figure 6 Pipe Adaptors**

Adaptors are supplied for use on small pipes. The diagrams above show how these are fitted around the pipe. The top pipe adaptor clips into the ends of the guide rail.

**5.4 Attaching the U1000MKII-FM to the pipe**

After applying the Gel pads centrally on the sensors, then follow the four steps shown in Figure 7 below to attach the U1000MKII-FM to the pipe.



Remove the covers from the Gel pads. Ensure there are no air bubbles between pad and sensor base.



Check separation distance table on page 8 or program unit before clamping guide rail to pipe, using the supplied banding. Then release and **REMOVE** sensor locking screws.



Connect sensors to the electronics assembly before applying power. Sensor leads can be connected either way round.



Confirm the unit is working correctly before attaching the electronic assembly onto guide rail assembly.

Figure 7 simple steps to attaching the U1000MKII on the pipe

*Note...The locking screws and washers should be kept in case it is necessary to change the location of the guide rail and sensors. See the relocation section for the procedure to do this*

### 5.5 U1000MKII-FM Interface Cables

The U1000MKII-FM interface cable supplied is a 6-core cable for power, 4-20mA and pulse output connections and a separate 4 core plug-in cable for the Modbus connections.

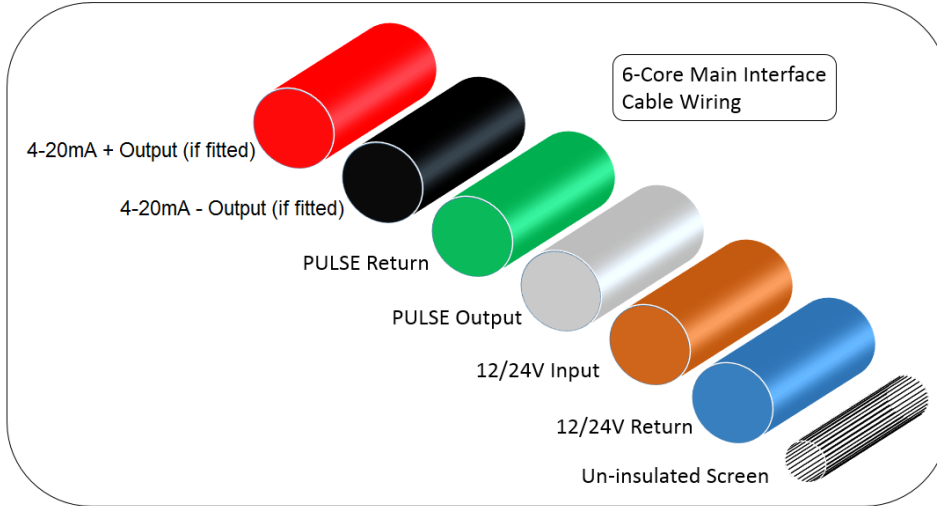

The un-insulated wire is the connection to the screen of the cable and should be earthed for full immunity to electrical noise.

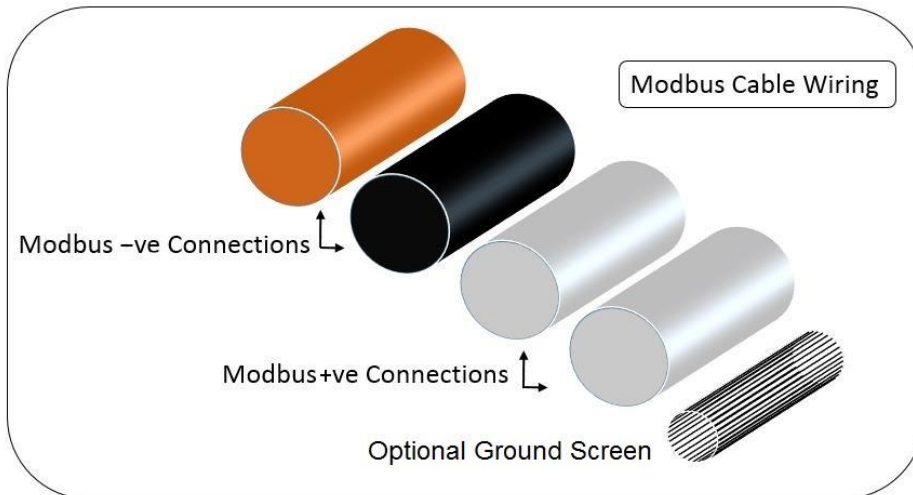

Figure 8. U1000MKII-FM Interface and Modbus Cables

### 5.6 Connecting the U1000MKII-FM to the Supply

The U1000MKII-FM will operate within the voltage range 12 - 24V ac/dc. The supply must have a minimum rating of 7VA per instrument. Connect the external power supply to the Brown and Blue wires of the six-core cable.

For safety, connecting the U1000MKII to a power supply via a mains rated transformer is the responsibility of the installer to conform to the regional voltage safety directives.

**5.7 Pulse Output connection**

The isolated pulse output is provided by a SPNO/SPNC MOSFET relay which has a maximum load current of 500mA and maximum load voltage of 48V AC. The relay also provides 2500V isolation, between the sensor’s electronics and the outside world.

The pulse output is available at the White and Green wires. Electrically this is a volt, or potential free contact, and when selected as a low flow alarm is configurable NO/NC.

**5.8 Current Output (If fitted)**

The isolated 4-20mA is a current source and can drive into a maximum load of 620Ω.

The 4-20mA current output is available at the Red and Black wires.

The polarities are shown Page 12 Figure 8.

The alarm current due to a flow outside the range specified or due to a loss of signal is set at 3.5mA.

**5.9 Modbus Connections (if fitted)**

A lead is provided for the Modbus connections that plugs into the electronics assembly near the power cable entry. The Brown and the Black are the -ve bus wire and both White wires are the +ve bus wire.

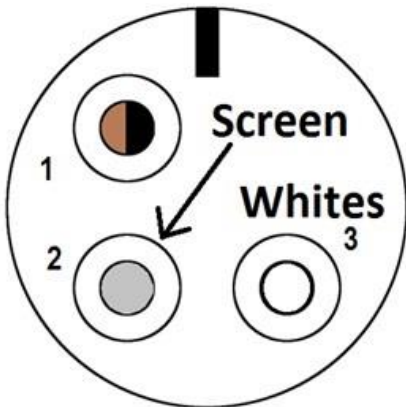

PIN	FUNCTION	COLOUR
1	BUS -ve	BLACK & BROWN
2	OPTIONAL GND	SCREEN
3	BUS +ve	BOTH WHITES
4	-	-

**Modbus Connector Cable Part - Binder 99-9210-00-04 (Front View)**

For reliable operation of a Modbus network the cable type and installation must comply with requirements in the Modbus specification document “MODBUS over Serial Line Specification & Implementation guide V1.0”.

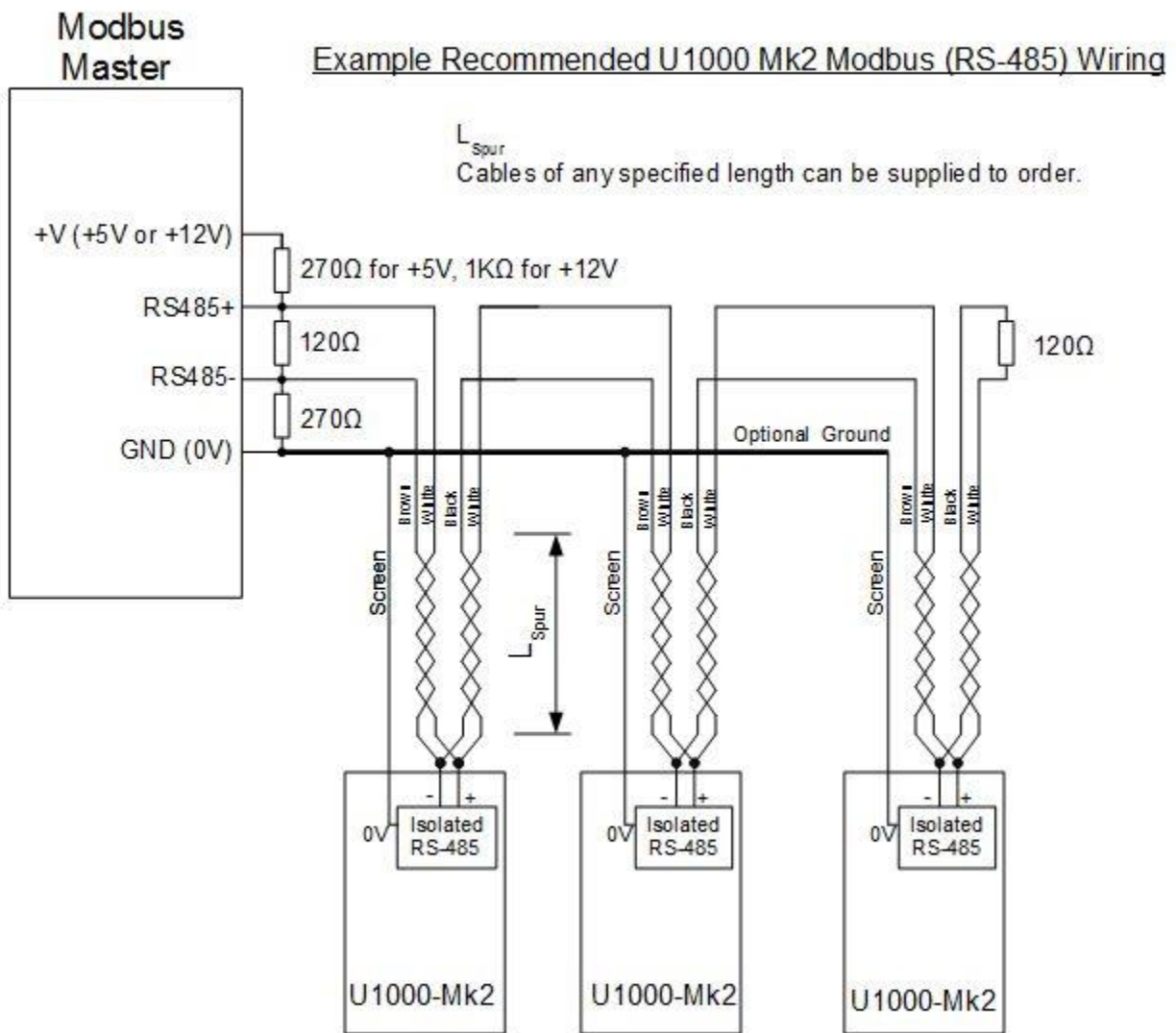

**5.10 Cable Screen**

For full immunity to electrical interference the screen of the power/pulse output cable and modbus cable should be connected to Earth.

## 6 Powering up for the first time

Powering up for the first time will initiate the sequence shown in Figure 9:

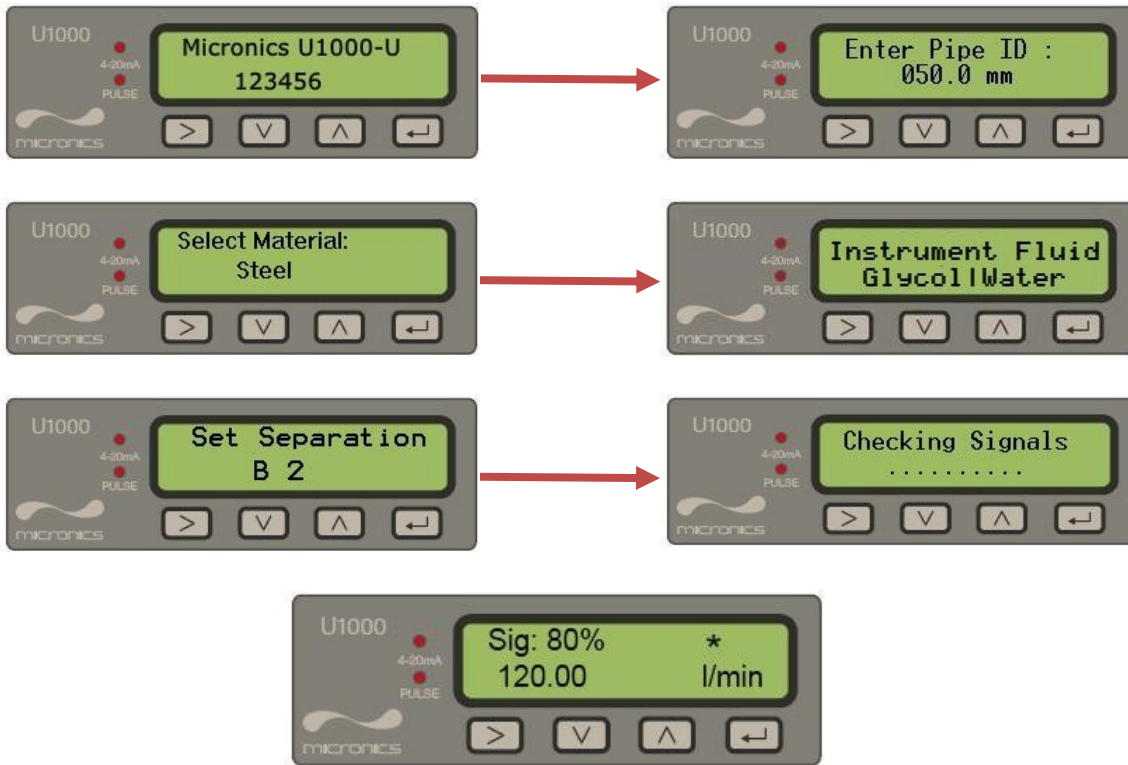

Figure 9 Initial power up screens

1. The start-up screen is displayed for 5 seconds.
2. The user enters the pipe ID and then the material by scrolling through the available list. (Refer to section 5.2)
3. The U1000MKII-FM checks for a valid signal.
4. If a valid signal is found, signal strength and flow magnitude are displayed. The signal strength should be at least 40% for reliable operation. The direction of flow when powered up will be set as that for positive flow. The current output and pulse output will relate to the flow in this direction. If the flow is reversed then the flow rate will still be displayed but the activity indication will change from an asterisk to an exclamation mark. No pulses will be generated, and the current will go to the 3.5mA alarm state if the flow is reversed.

If the flow value is displayed as “-----” this indicates that there is no usable signal from the sensors. The cause of this could be:

<ul style="list-style-type: none"> <li>• Incorrect pipe data</li> </ul>	<ul style="list-style-type: none"> <li>• No Gel pad or grease on the sensor</li> </ul>
<ul style="list-style-type: none"> <li>• Sensor not in contact with the pipe</li> </ul>	<ul style="list-style-type: none"> <li>• Very poor pipe condition-surface/inside</li> </ul>
<ul style="list-style-type: none"> <li>• Air in the liquid/pipe</li> </ul>	

**Please note:**

There is little available data on the specific heat capacity (K factor) for water glycol mixes and there is no practical method of determining the percentage of glycol in a system or the type of glycol in use. The calculations are based on a Water/Ethylene glycol mix of 30%.

In practical terms the results should not be considered more than an approximation as:

The fluid speed of sound can vary between 1480ms and 1578ms

No temperature compensation curve is available for water/glycol mixes,

The percentage of Glycol can vary the specific heat capacity from 1.00 to 1.6 J/M<sup>3</sup> \* K

The type of glycol added can change the specific heat capacity and fluid speed of sound considerably.

The Factory enabled user set-up of the application relies on the installer to set the correct operating parameters, a considerable variation in results can be obtained from incorrectly set-up units.

**6.1 How to enter the Pipe ID**

Figure 10 shows the Enter Pipe ID screen after an initial power up.

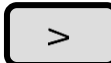



Figure 10 Enter Pipe ID Screen (Metric)

Initially, the hundreds unit (050.0) will blink.

Press the  key to increment the hundreds digit (050.0) in the sequence 0, 1. Press once to increment digit between 0 and 1.

Press the  key to decrement the hundreds digit in the sequence 1, 0. Press once to decrement digit between 1 and 0.

Press the  key to move to the tens digit (050.0). The tens digit should now blink. Increment the tens digit in the sequence 0,1,2,3,4,5,6,7,8,9,0 using the  key. Press once to increment digit through the numeric sequence. Decrement the tens digit in the sequence 9,8,7,6,5,4,3,2,1,0,9 using the  key. Press once to increment digit through the numeric sequence.





Press the  key to move to the units digit (050.0). The units digit should now blink. Increment or decrement the units digit in an identical manner to the tens digit described above.

Press the  key to move to the decimal digit (050.0). The decimal digit should now blink. Increment or decrement the decimal digit in an identical manner to the tens digit described above.

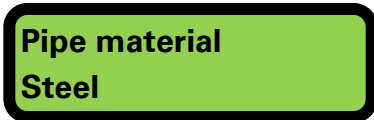
Press the  key to enter the Pipe ID numerical value, and move to the next screen



Use  and  keys to scroll through the pipe materials and then press

 To select the material and complete the setup procedure.

If any of the parameters need to be changed from the default values, for example different units are required, and then the menu system must be activated via the password menus (see section 8).

## 6.2 Pulse output

Pulse output can be set up to operate one of four modes, namely volumetric, frequency, Low Flow Alarm and Loss of Flow (Signal) Alarm. The Alarm function allows the user to set the alarm to Normally Open or Normally Closed.

### 6.2.1 Volumetric mode

In Volumetric mode, each pulse output represents a measured volume of 10 litres (default value). In Volumetric mode, with the Vol per Pulse set to 1 and the pulse width set to 50ms, the maximum number of pulses that can be output (without storage) is  $1/(0.050*2) = 10$  pulses per second. If the flow rate in the pipe is such that more than 20 pulses per second are generated, a Pulse Overflow error may eventually occur if the stored number of pulses exceeds 1000. To avoid this, set the Vol per Pulse to 10 litres, or reduce the Pulse Width value.

### 6.2.2 Frequency mode

In Frequency mode, the pulse output frequency is proportional to the flow rate within a specified frequency range of 1 – 200Hz. The units of the flow rate are **fixed as litres per second**.

The conversion factors from imperial units are:-

US gallons/minute multiply by 0.06309  
US gallons/hour multiply by 0.00105  
Imperial gallons/minute multiply by 0.07577  
Imperial gallons/hour multiply by 0.001263

### **6.2.3 Flow Alarm - Low Flow or Signal loss**

It is possible to use the pulse output as a High/Low Flow Alarm or a Signal Loss Alarm.

For the High/Low Alarm the user can set a range between 0 and 9999 (no decimal places), in the same units being used to measure flow. The default setting is normally open, but the user can select between N/O and N/C. There is a 2.5% hysteresis on the switching of the output. Once turned on the flow rate must rise by 2.5% more than the set value to turn it on/off again.

If the flow reading (Signal) is lost, as indicated by the flow rate being displayed as "-----", the alarm will be triggered. The Pulse LED will indicate the state of the alarm. The default setting is normally open, but the user can select between N/O and N/C.

### **6.3 4-20mA Current Output (if fitted)**

The default 4-20mA output setting is ON, and the 4-20mA LED on the keypad will be illuminated. The default flow for 20mA output will be automatically set depending on the pipe size. The default flow for 4mA is 0. This can be changed, see section 8.

If the flow reading is greater than that set as the 20mA value, or there is negative flow, or no flow signal can be detected, then an alarm current of 3.5mA will generated.

**Note:** The 4-20mA current output is factory calibrated.

### 6.4 Modbus(if fitted)

The Modbus RTU interface is configured via the Modbus sub menu in the password controlled menu.

The data rate can be selected in the range 1200 to 38400 baud.

The address can be set in the range 1 to 126.

Polling Rate 1000ms (1sec). Time out after 5 seconds.

The instrument responds to the “read holding registers” request (CMD 03).

If the flow reading is invalid then the flow value will be zero.

If a temperature sensor goes out of range then the value will go to -11.

Both of these faults will set the relevant status bit. The following registers are available.

Modbus Register	Register Offset	Type	Typical Contents	Meaning	Notes
n/a	n/a	Byte	0x01	Instrument Address	
n/a	n/a	Byte	0x03	Instrument Command	
n/a	n/a	Byte	0x40	Number of bytes to read	
40001	0	Int-16	0x00 0xac	Device ID	0xAC Energy Meter
40002	1	Int-16	0x00 0x00	Status	0x0000 OK Not[0x0000] Fault
40003	2	Int-16	0x00 0x04	System Type	0x04 Heating system 0x0C Chiller system
40004	3	Int-16	0x00 0x01	Serial Identifier	
40005	4	Int-16	0x23 0x45		
40006	5	Int-16	0x60 0x00		
40007	6	iee754	0x40 0x1f	Measured Velocity	Units in m/s
40008	7		0x67 0xd3		
40009	8	iee754	0x41 0x8c	Measured Flow	Units in m3/hr for Metric Units in US Gal/m for Imperial
40010	9		0xd8 0xb0		
40011	10	iee754	0x42 0x1c	Calculated Power	Units in kW for Metric Units in BTU/s for Imperial
40012	11		0x2e 0x34		
40013	12	iee754	0x44 0x93	Calculated Energy	Units in kWh for Metric Units in kBTU for Imperial
40014	13		0xc6 0xe8		

40015	14	iee754	0x41	Measured Temperature (Hot)	Units in Degrees Celsius for Metric Units in Degrees Fahrenheit for Imperial
40016	15		0x98		
			0x00		
			0x00		
40017	16	iee754	0x41	Measured Temperature (Cold)	Units in Degrees Celsius for Metric Units in Degrees Fahrenheit for Imperial
			0x88		
40018	17		0x00		
			0x00		
40019	18	iee754	0x40	Measured Temperature (Difference)	Units in Degrees Celsius for Metric Units in Degrees Fahrenheit for Imperial
			0x00		
40020	19		0x00		
			0x00		
40021	20	iee754	0x60	Measured Total	Units in m3 for Metric Units in US Gal for Imperial
			0xef		
40022	21		0x3c		
			0x1c		
40023	22	Int-16	0x00	Instrument Units	0x00 Metric 0x01 Imperial
			0x00		
40024	23	Int-16	0x00	<b>Instrument Gain</b>	<b>Gain in dB</b>
			0x01		
40025	24	Int-16	0x00	<b>Instrument SNR</b>	<b>SNR in dB</b>
			0x0a		
40026	25	Int-16	0x00	<b>Instrument Signal</b>	<b>Signal in %</b>
			0x62		
40027	26	iee754	0x42	Measured Delta-Time Difference	Diagnostic Data Units in nanoseconds
			0xc9		
40028	27		0xff		
			0x7d		
40029	28	iee754	0x42	Instrument ETA	Diagnostic Data Units in nanoseconds
			0xa8		
40030	29		0x8b		
			0xf5		
40031	30	iee754	0x42	Instrument ATA	Diagnostic Data Units in nanoseconds
			0xc8		
40032	31		0x00		
			0x00		
n/a	n/a	Int-16	0xed	CRC-16	
			0x98		

On a unit set to Imperial the flow in US Gallons.

Figure 12 Modbus registers



## 7 Subsequent Power-ON Sequence

If the power supply is cycled OFF/ON after the unit is in the flow reading screen all subsequent start-ups will use the same configuration as was previously entered. If the configuration needs to be changed for any reason, the user can make use of the password-controlled menu as described in section 8.

## 8 Password Controlled Menus

The password controlled menu allows the user some flexibility to change the default settings:

<b>User Password (71360):</b>
• Setup Menu
• Comms Menu
• Pulse Output Menu
• Calibration Menu
• Totaliser Menu

Press the  key to get to the screen prompting for the password, which is entered using the method shown in 9.1.2. To exit the password controlled menu navigate to the Exit screen and press the  key. If you wish to abandon entering the password then wait until the display returns to the flow reading screen.

General procedure for changing menu settings.

## 9 General Procedure for changing menu settings

### 9.1.1 Selection menus

When a password controlled menu is selected the procedure for changing the default setting is the same for all menus. For example, consider the Flow Units menu shown in Figure 12.

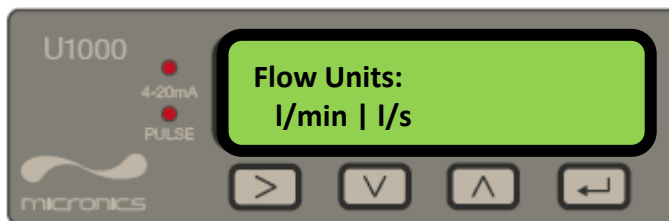



Figure 12 Flow Units menu

The default value 'l/min' will blink to indicate that this is the current setting. To change to 'l/s', press the  key. Now the 'l/s' units will blink to indicate that this is now the selected units. Press the  key to confirm the change.

There are other default settings where the  and  keys are used to scroll through the options.

### 9.1.2 Data entry menus

Menus containing a numeric value can be altered using the following procedure. For example, consider changing the Flow at maximum current from the default setting 1000 litres as indicated in Figure 13 to 1258 litres.

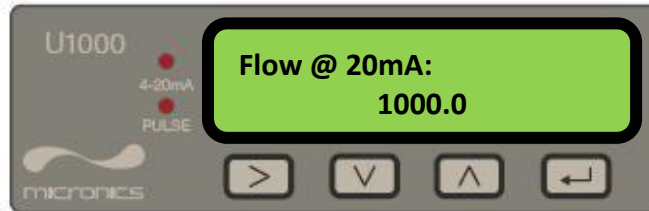

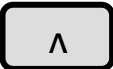



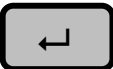



Figure 13 Example of a Data entry screen

- Press the  key twice to select the hundreds unit (1000.0) which will now blink
- Press the  key twice to increment the hundreds unit from 0 to 2 (1200.0)
- Press the  key once to select the tens unit (1200.0) which will now blink
- Press the  key five times to increment the hundreds unit from 0 to 5 (1250.0)
- Press the  key once to select units (1250.0) which will now blink
- Press the  key twice to decrement the units from 0 to 8 (1258.0)
- Press the  key to confirm the change

All numeric data menus can be changed in this way.

### 9.2 User Password controlled menu structure

Ensure that the instrument is in Flow Reading mode or Total Flow mode then press the  key to go to the user password menu. Enter 71360 using the procedure explained in section 9.1.2 to enter the password.

The flow chart shown in Figure 14 shows the user password menu structure. To skip over any menu item that should remain unchanged, simply press the  key.

PASSWORD CONTROLLED MENUS

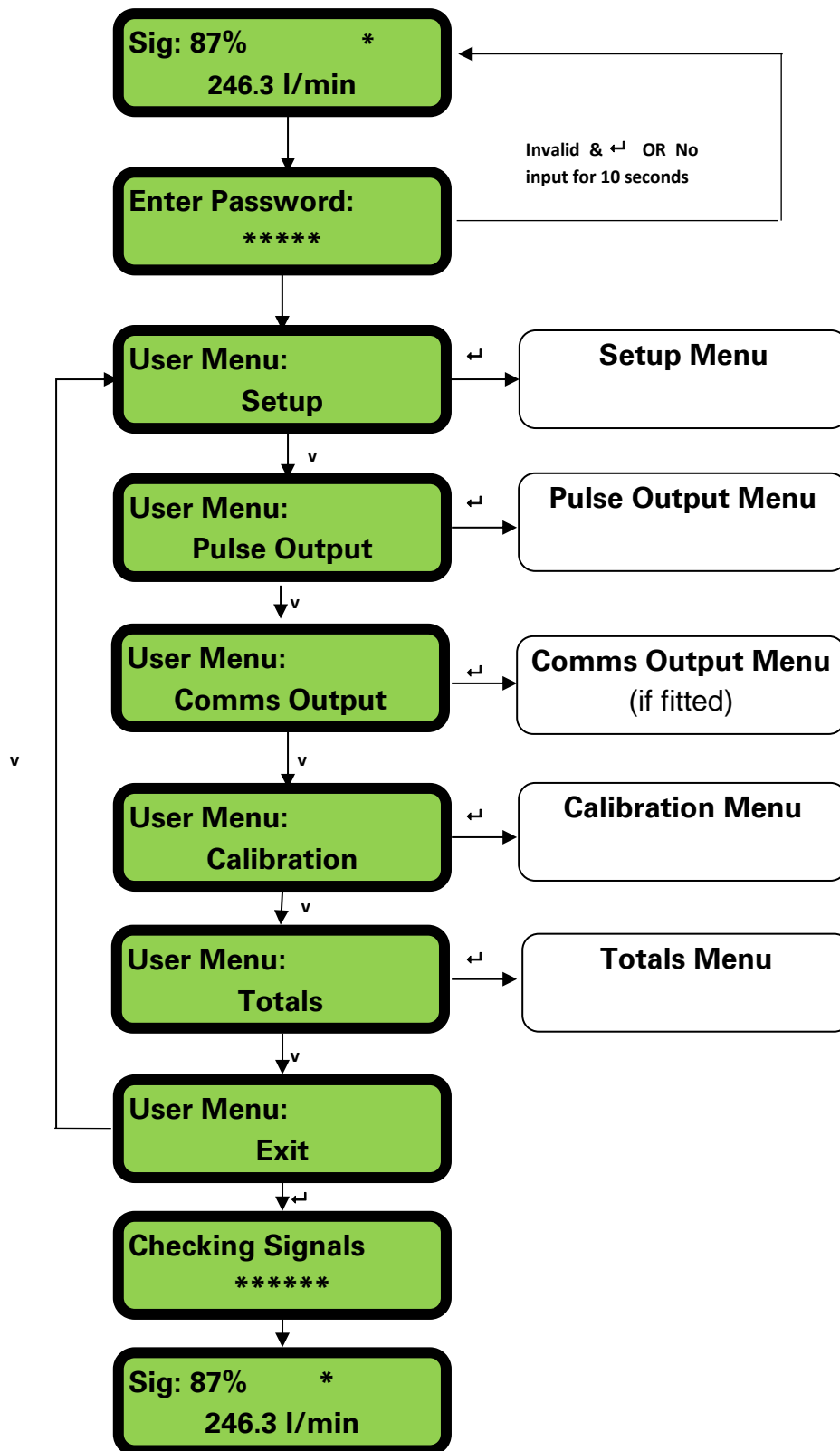

Figure 14 Main Menu

SETUP MENU

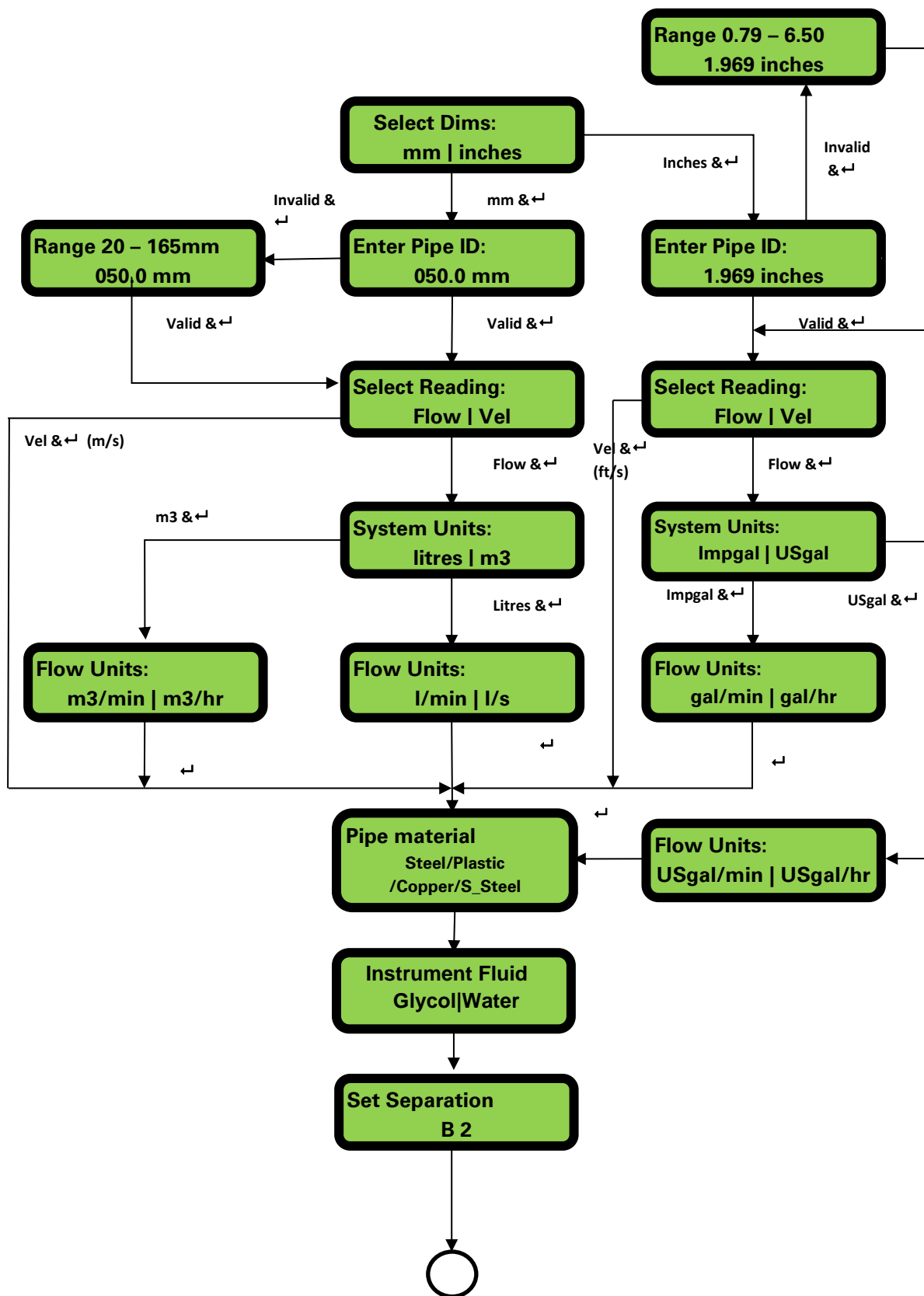

Figure 15 Setup Menu



PULSE OUTPUT MENU

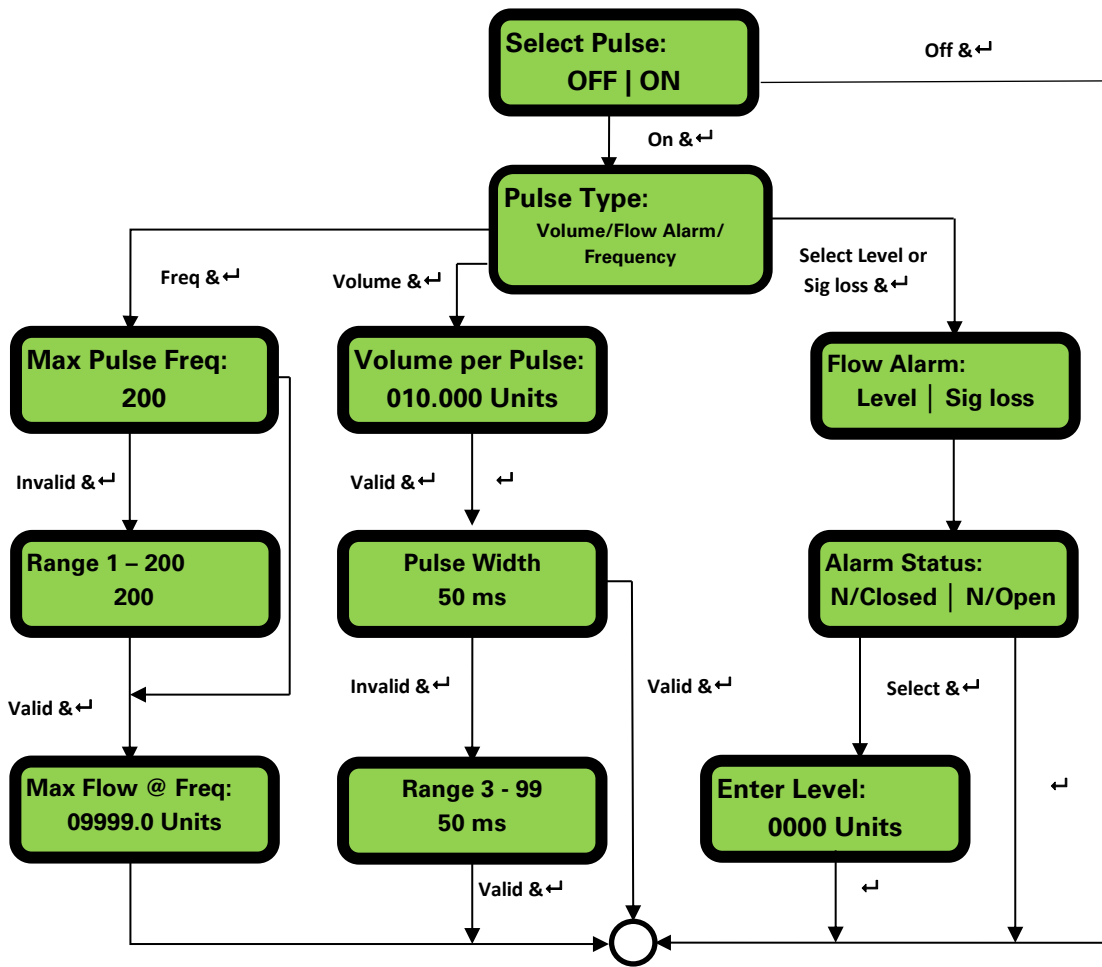

Figure 16 Pulse Output Menu

**CURRENT OUTPUT MENU (IF FITTED)**

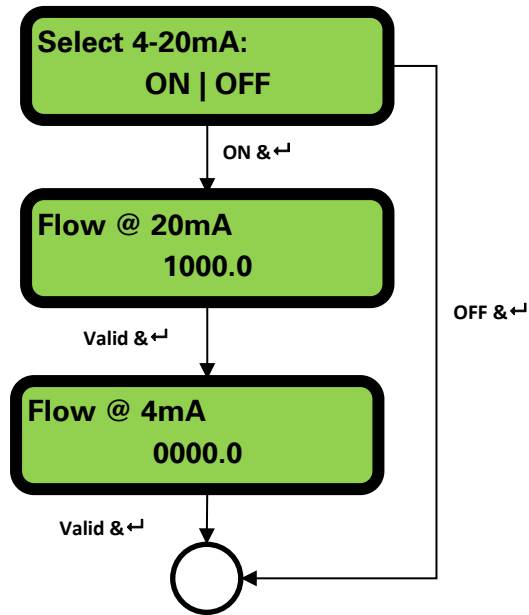

Figure 17 4-20mA Menu

**MODBUS SETUP MENU**

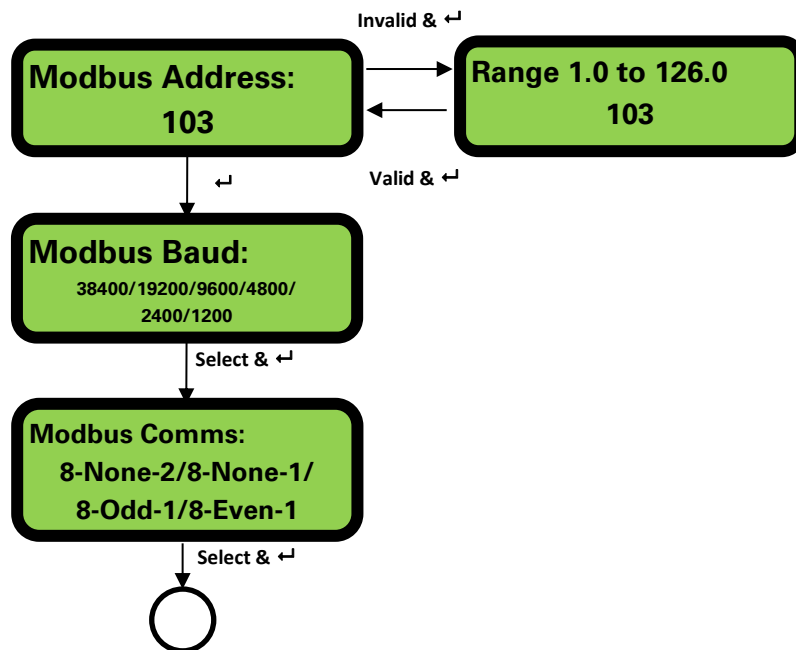

Figure 18 Modbus Setup Menu

**CALIBRATION MENU**

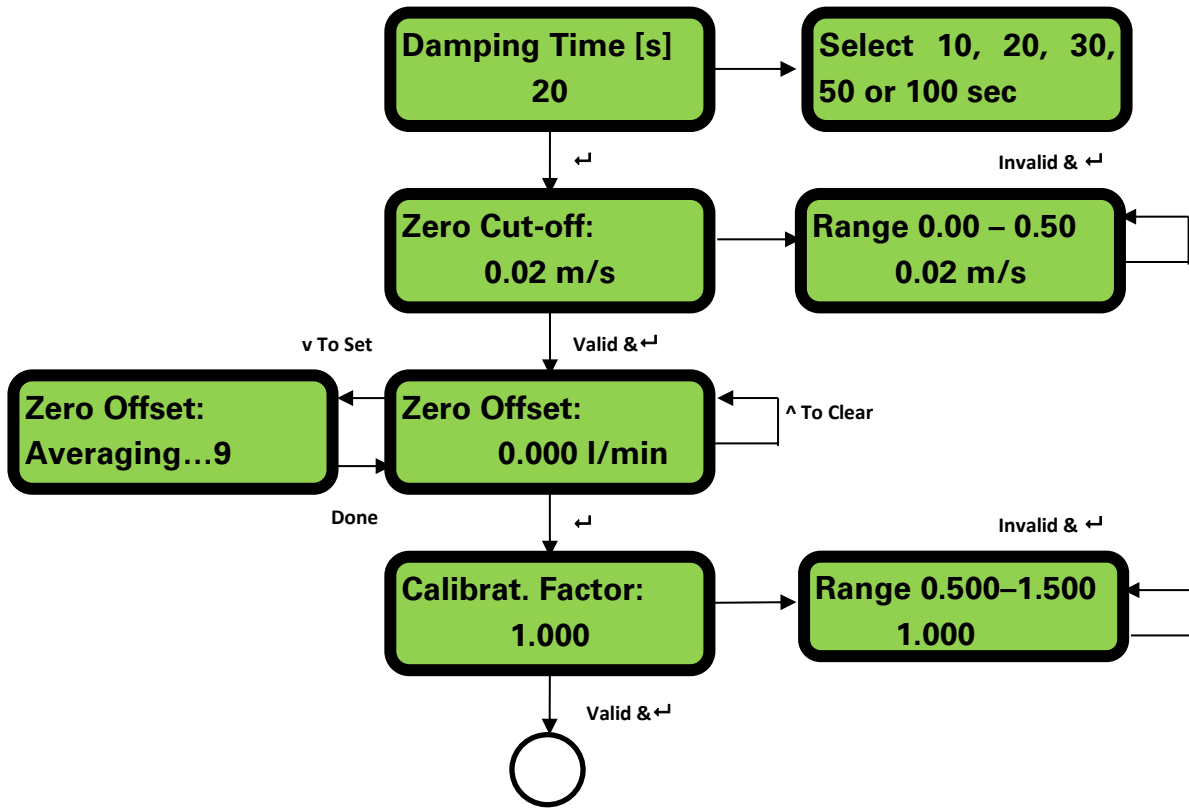

Figure 18 Calibration Menu

**TOTALISER MENU**

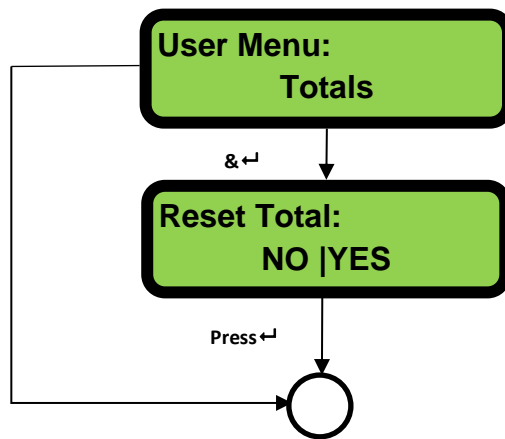



Figure 20 Totaliser Menu

## 10 Diagnostics Menu

The diagnostics menu provides some additional information about the flowmeter and its setup. The menu can be accessed by pressing the  key from the main flow-reading screen. The menu shown below describes the various diagnostics items.

### DIAGNOSTICS MENU

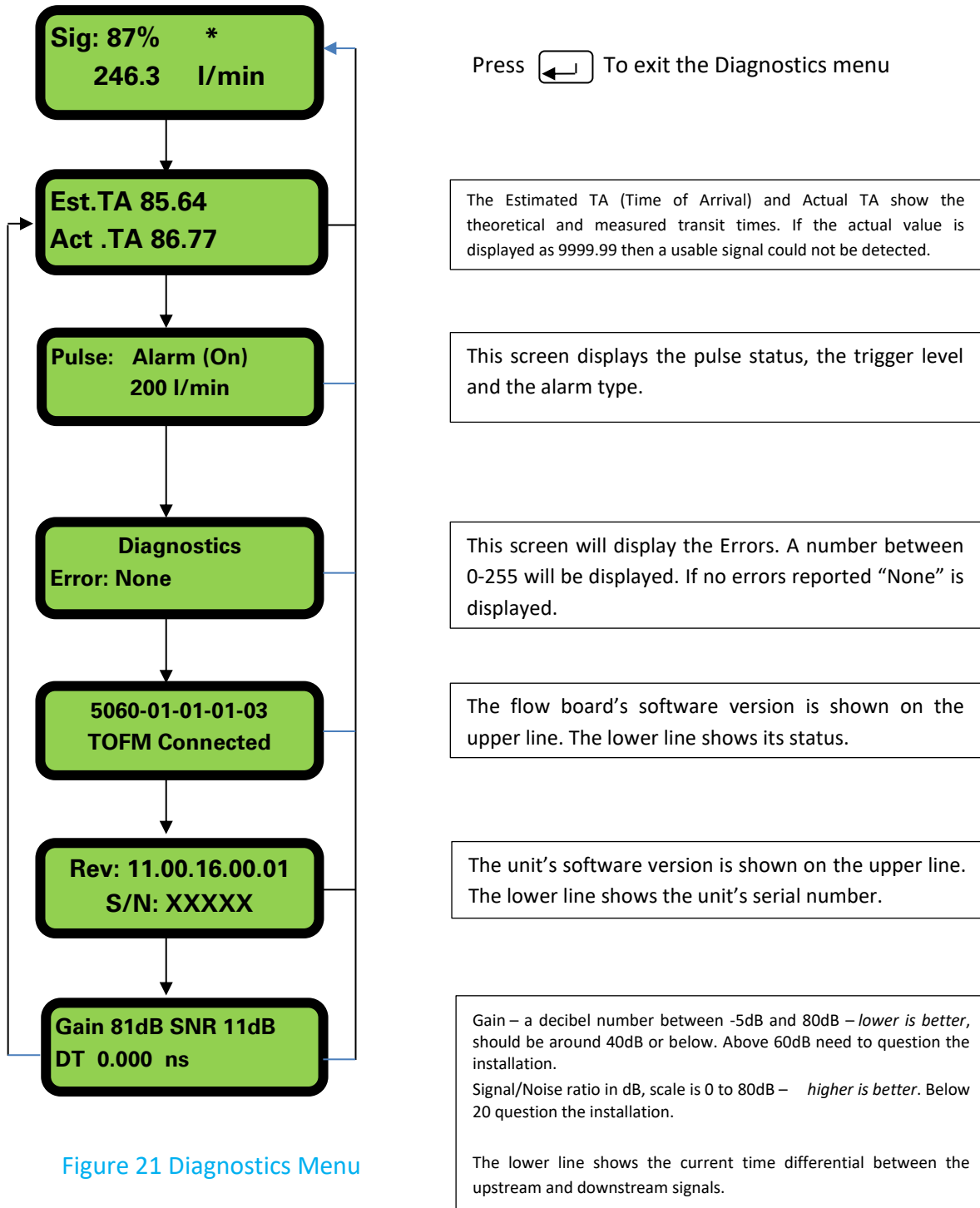

Figure 21 Diagnostics Menu

## 11 Relocation of guide rail

If it is necessary to relocate the guide rail and sensor assembly use the following procedure.

1. Remove complete assembly from the pipe.
2. Undo the screw at the end of the guide rail and gently lift the same end as shown.
3. The opposite end of the electronics can now be released from the guide rail.



Figure 22

4. Disconnect the sensors.
5. Remove the original Gel pads from the sensors.
6. Push the sensor blocks into the guide rail so that the washers and locking screws can be refitted.
7. Place replacement Gel pads down the centre of the sensor block.
8. Follow the procedure in section 5 for re-installing the guide rail on the pipe.

## 12 Appendix I – U1000MKII-FM Specification

Table 1 lists the U1000MKII-FM Product Specification.

<b>General</b>	
Measuring Technique	Transit time
Measurement channels	1
Timing Resolution	±50ps
Turn down ratio	200:1
Flow velocity range	0.1 to 10m/s
Applicable Fluid types	Clean water with < 3% by volume of particulate content, or up to 30% ethylene glycol.
Accuracy	±3% of flow reading for velocity rate >0.3m/s
Repeatability	±0.15% of measured value
Selectable units for metric (mm)	Velocity: m/s Flow Rate: l/s, l/min, m <sup>3</sup> /min, m <sup>3</sup> /hr Volume: litres, m <sup>3</sup>
Selectable units for Imperial (inches)	Velocity: ft/s Flow rate: gal/min, gal/hr, USgal/min, USgal/hr Volume: gals, USgals
Totaliser	14 digits with roll over to zero
Languages supported	English only
Power input	12 – 24V ac or dc
Power consumption	7VA maximum
Cable	5m screened 6 core
<b>Pulse Output</b>	
Output	Opto-isolated MOSFET volt free contact (NO/NC).
Isolation	2500V
Pulse width	Default value 50ms; programmable range 3 – 99ms
Pulse repetition rate	Up to 166 pulses/sec (depending on pulse width)
Frequency mode	200 Hz maximum (Range 1-200)
Maximum load voltage/current	48V AC / 500mA
<b>Current Output (If fitted)</b>	
Output	4 – 20mA
Resolution	0.1% of full scale
Maximum load	620Ω
Isolation	1500V opto-isolated
Alarm current	3.5mA
<b>Modbus (if fitted)</b>	
Format	RTU
Baud rate	1200, 2400, 4800, 9600, 19200, 38400
Data -Parity-Stop Bits	8-None-2, 8-None-1, 8-Odd-2, 8-Even-1
Standards	PI-MBUS-300 Rev. J
Physical connection	RS485
<b>Enclosure</b>	
Material	Plastic Polycarbonate
Fixing	Pipe mountable
Degree of Protection	IP54
Flammability Rating	UL94 V-0
Dimensions	250mm x 48mm x 90mm (electronics + guide rail)

Weight	0.5kg
<b>Environmental</b>	
Maximum Pipe temperature	0°C to 85°C
Operating temperature (Electronics)	0°C to 50°C
Storage temperature	-10°C to 60°C
Humidity	90% RH at 50°C Max
<b>Display</b>	
LCD	2 line x 16 characters
Viewing angle	Min 30°
Active area	58mm (W) x 11mm(H)
<b>Keypad</b>	
Format	4 key tactile feedback membrane keypad

### 13 Appendix II – Default values

The settings will be configured at the factory for either metric or imperial units. Table 2 lists the metric default values.

**Table 2 System Default Values**

Table 3 lists the default values when Imperial dimensions are selected.

**Table 3 System Default Values**

Metric	
Parameter	Default Value
Dimensions	mm
Flow Rate	l/min
Pipe size	50 (mm)
4-20mA	On, 4-20mA selected
Pulse Output	Off
Volume per Pulse	10 litres
Pulse Width	50ms
Damping	20 seconds
Calibration Factor	1.000
Zero Cut-off	0.02m/s
Zero Offset	0.000l/min

Imperial	
Parameter	Default Value
Dimensions	inches
Flow Rate	USgal/min
Pipe size	1.969 (inches)
4-20mA	On, 4-20mA selected
Pulse Output	Off
Volume per Pulse	2.642 US gallons
Pulse Width	50ms
Damping	20 seconds
Calibration Factor	1.000
Zero Cut-off	0.07 ft/s
Zero Offset	0.000gal/min

## 14 Appendix III – Error and Warning Messages

### Error Messages

Error Messages are displayed as a number in the diagnostics menu. Contact Micronics if other messages appear.

Error Meaning	Status Byte								
	Bit#7	Bit#6	Bit#5	Bit#4	Bit#3	Bit#2	Bit#1	Bit#0	
RTD I2C failed								1	
RTD Thot failed							1		
RTD Tcold failed						1			
TOFM signal lost					1				
TOFM board failed				1					
TOFM window failed			1						
TOFM sensor type failed		1							
TOFM I2C failed	1								
<b>Examples - Meaning</b>									text displayed
Fully functioning instrument	0	0	0	0	0	0	0	0	None
No ultrasonic signal	0	0	0	0	1	0	0	0	8
Both temperature probes either failed or not plugged in	0	0	0	0	0	1	1	0	6
TOFM I2C failed and hot temperature probe not plugged in	1	0	0	0	0	0	1	0	130
Fully failed instrument	1	1	1	1	1	1	1	1	255

Error Message	Error Meaning
None or 0	None
2	Hot sensor error
4	Cold sensor error
6	Hot and Cold sensor error
8	No flow signal
10	Hot error and no flow signal
12	Cold error and no flow signal
14	Hot and Cold error no flow signal



### Modbus Error Messages (if Modbus fitted)

Test case	Transmitter							
	Address	Command	Start Register		Length (no of registers)		CRC-16	
	[1 byte]	[1 byte]	[2 bytes]		[2 bytes]		[2 bytes]	
No error	0x01	0x03	0x00	0x00	0x00	0x20	0x44	0x12
Incorrect function request	0x01	0x0C	0x00	0x00	0x00	0x20	0x10	0x13
incorrect register start	0x01	0x03	0x00	0xEF	0x00	0x20	0x75	0xE7
Incorrect register length	0x01	0x03	0x00	0x12	0xFF	0x02	0x25	0xFE
slave is busy	0x01	0x03	0x00	0x00	0x00	0x20	0x44	0x12
incorrect CRC-16	0x01	0x03	0x00	0x20	0x00	0x20	0x44	0xFF

Receiver				Comments	
Address	Command	Error code	CRC-16		
[1 byte]	[1 byte]	[1 byte]	[2 bytes]		
0x01	0x03	None	n/a	n/a	Example of a good message
0x01	0x8C	0x01	0x85	0x00	The only acceptable commands are 0x03 and 0x06
0x01	0x83	0x02	0xC0	0xF1	Incorrect register start
0x01	0x83	0x03	0x01	0x31	Incorrect register length
0x01	0x83	0x06	0xC1	0x32	slave is busy processing and is unable to respond
0x01	0x83	0x07	0x00	0xF2	CRC is incorrect

### Flow errors

A signal strength of less than 40% indicates poor set up of the instrument, and the installation should be checked or possibly moved to a different site.

### Flow warnings

A signal strength of less than 40% indicates poor set up of the instrument, and the installation should be checked or possibly moved to a different site. A negative flow is indicated by an "!" being displayed on the top line instead of a "\*" .

### Warnings

These generally advise the user that the data entered is out of the specified range.

1. When an invalid Pipe ID is entered, the warning message shown below is displayed, prompting the user to enter a value between 20 and 165mm depending on the product purchased.

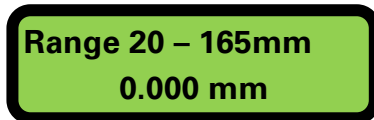

2. If supplied, when the 4-20mA current output is turned ON, the Flow at Maximum and Minimum current can be changed under password control. The valid range is 0 – 99999.0 If an invalid value is entered the following warning message is displayed:

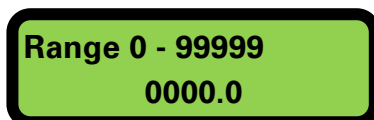

3. When programming a Frequency Pulse output the frequency is limited to the range 1 to 200 Hz. If an invalid value is entered then the following warning message is displayed.



**Range 1 - 200**  
**200**

4. When programming a Volume Pulse output the pulse width is limited to the range 3 to 99ms. If an invalid value is entered then the following warning message is displayed.



**Range 3 - 99**  
**0000.0**

5. When programming the Zero Cut-off this is limited to the range 0.000 to 0.500. If an invalid value is entered then the following warning message is displayed.

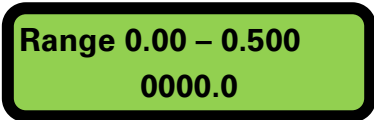

**Range 0.00 - 0.500**  
**0000.0**

6. When programming the Calibration Factor this is limited to the range 0.5 to 1.5. If an invalid value is entered then the following warning message is displayed.



**Range 0.500 - 1.500**  
**0000.0**

#### Updates

*Apr 19 Modbus cable wiring diagram page 12 and Modbus Connections Image page 13 and 14.*

## 15 Declaration of Conformity



### MICRONICS EU Declaration of Conformity

#### Micronics Ltd

Knaves Beech Business Centre  
Davies Way, Loudwater,  
High Wycombe, Bucks.  
HP10 9QR

#### The Products Covered by this Declaration Ultrasonic flow meter U1000, U1000-HM and U1000MKII

This product is manufactured in accordance with the following Directives and Standards.

Directive 2014/30/EU of the European Parliament and of the Council of 26 February 2014 on the approximation of the laws of the Member States relating to electromagnetic compatibility

Directive 2014/35/EU of the European Parliament and of the Council of 26 February 2014 on the harmonisation of the laws of Member States relating to electrical equipment designed for use within certain voltage limits

#### The Basis on which Conformity is being Declared

The manufacturer hereby declares under his sole responsibility that the products identified above comply with the protection requirements of the EMC directive and with the principal elements of the safety objectives of the Low Voltage Equipment directive and that the following standards have been applied:

BS EN 61010-1:2010 Safety requirement for electrical equipment for measurement control and laboratory use. Part 1 General requirements

BS EN61326-1:2013 Electrical equipment for measurement control and laboratory use EMC requirements. Part 1: General requirements

BS EN61326-2-3:2013 Electrical equipment for measurement control and laboratory use EMC requirements. Part 2-3: Particular requirements – Test configuration and performance criteria for transducers with integrated or remote signal conditioning.

This declaration of conformity is issued under the sole responsibility of the manufacturer.

**Signed for and on behalf of : Micronics Ltd.**

Signature: \_\_\_\_\_

Printed Name: Michael Farnon

Title: Managing Director

Date: April 2018

Location: Loudwater

#### Attention!

The attention of the specifier, purchaser, installer, or user is drawn to special measures and limitations to use which must be observed when these products are taken into service to maintain compliance with the above directives.

Details of these special measures and limitations to use are available on request, and are also contained in the product manuals.

Registered Office: Micronics Limited, Knaves Beech Business Centre, Davies Way, Loudwater, Buckinghamshire, HP10 9QR

Web site: [www.micronicsflowmeters.com](http://www.micronicsflowmeters.com) Tel: +44 (1628) 810456

Directors: E.J. Farnon, E. Farnon, M.A. Farnon, D.B. Leigh

Registration No. 1289680 V.A.T. Registration No. 303 6190 91

