



Micronics™

UX5000

UX5000 Non-Invasive Flow Meter



User Manual

Micronics Ltd, Kenfig Industrial Estate
Margam, Port Talbot, SA13 2PW, UK

Telephone: +44(0)1628 810456

E-mail: sales@micronicsltd.co.uk

www.micronicsflowmeters.com

CONTENTS

- 1 CERTIFICATION AND COMPLIANCE..... 1**
- 1.1 Certification and Compliance..... 1
 - 1.1.1 EMC, Safety, Weee, RoHS 1
 - 1.1.2 Hazardous Area Classification ATEX, IECEx & UKEX..... 1
 - 1.1.3 DCSIU Hazardous Area Label 1
 - 1.1.4 RMU Hazardous Area Labels..... 2
 - 1.1.5 Ultrasonic Flow Sensor Hazardous Area Labels..... 2
- 1.2 Explanation of Symbols 2
- 1.3 Safety..... 3
 - 1.3.1 Pre-Installation Checks 3
 - 1.3.2 Specific Conditions of Use 3
 - 1.3.3 Operating Environment 3
- 2 INTRODUCTION 5**
- 2.1 General Description and Intended Use..... 5
- 2.2 How Does It Work? 5
- 2.3 Package Contents..... 6
- 2.4 System Configuration..... 8
- 3 INSTALLATION 9**
- 3.1 Unpacking..... 9
- 3.2 Prerequisites 9
- 3.3 Software Requirements 9
- 3.4 Identify Suitable Location 10
 - 3.4.1 Clean the Pipe’s Flow Sensor Contact Area 11
- 3.5 Power and Signal Cables 11
 - 3.5.1 Field Wiring 11
- 3.6 Opening and Closing the DCSIU Enclosure 14
 - 3.6.1 Cable Entry 14
 - 3.6.2 Power Supply 15
 - 3.6.3 Pulse Output Connection 16
 - 3.6.4 Current Output 16
 - 3.6.5 Modbus Connections 16
 - 3.6.6 Earthing 16
 - 3.6.7 Gland Entries..... 16
- 3.7 Power Test 17

3.8	Mounting Options	17
3.8.1	Mounting the DCSIU	17
3.8.2	Mounting the RMU	18
4	SOFTWARE CONFIGURATION	20
4.1	Software Installation	20
4.2	UX5000 tab.....	21
4.3	Units tab.....	24
4.4	Fluid 1/2 tab	25
4.4.1	Application Temperature.....	26
4.4.2	Fluid Selection.....	26
	Select the fluid type from the drop down menu options:	26
4.4.3	Fluid Configuration Options.....	26
4.5	Pipe(s) tab	27
4.5.1	Pipe Selection Section.....	27
4.5.2	Pipe Material.....	27
4.5.3	Manual Inputs	28
4.5.4	Pipe Configuration Option	28
4.6	Liner(s) tab	28
4.6.1	Liner Options.....	29
4.6.2	Thickness.....	29
4.6.3	Liner Configuration	29
4.7	Sensor(s) tab	30
4.8	Diagnostics tab.....	31
4.8.1	Physical Parameters.....	31
4.8.2	System Diagnostics	32
4.9	Relays/Outputs tab	35
4.9.1	Output Configuration:.....	36
4.9.2	Analog Output Specifications:	36
4.9.3	Relay Configuration:	36
4.9.4	Relay Operating Modes	36
4.9.5	Alarm Setup	36
4.9.6	Pulse Setup.....	36
4.10	System/ID/RS485 tab.....	38
4.10.1	Identification.....	38
4.10.2	RS485	39
4.11	Configuration(s)	41

4.12	BluetoothLE.....	42
5	GUIDERAIL ASSEMBLY.....	43
5.1	Transducers in Reflex Mode	43
5.2	Using Transducers in Diagonal Mode	44
5.3	Attach the PT100 Probe(s)	45
6	MEASUREMENT MODE	45
7	TROUBLESHOOTING.....	47
7.1	No flow reading.....	47
7.2	Poor or inconsistent readings	47
7.2.1	Is sensor positioning correct?.....	47
7.2.2	Is there air or solids in the liquid/pipe?.....	47
7.2.3	Is there good contact between the sensor and pipe?.....	47
7.2.4	Is the pipe in good condition?	47
7.2.5	Is the pipe galvanised or composite?	48
7.2.6	Is the pipe data entered correctly?	48
7.2.7	Is the fluid a mixture?	48
7.3	Flow reading present when the system is closed	48
7.4	No flow reading visible when the system is active	48
7.5	Flow is reversed	48
7.6	Error and Warning Messages.....	49
7.6.1	Error Messages	49
8	APPENDIX.....	50
8.1	Specification.....	50
8.2	Spares.....	52
8.3	Maintenance and Calibration	53
8.3.1	Periodic Inspection	53
8.3.2	Sensor Cleaning.....	53
8.3.3	Sensor Regreasing.....	53
8.4	Dimensions.....	54
8.4.1	General Assembly	54
8.4.2	Display Unit (Digital Control and Signal Interface Unit) General Assembly	54
8.4.3	Remote Measurement Unit (RMU) General Assembly	55
8.4.4	Sensor Guiderail Assembly	55
8.5	Acronym Glossary	56

FIGURES

Figure 1: Principle of Transit-Time operation	5
Figure 2: UX5000 Contents	7
Figure 3: UX5000 system configuration.....	8
Figure 4: Location of unit	10
Figure 5: Removing the DCSIU cover	14
Figure 6: Terminal blocks and connectors	15
Figure 7: DCSIU Mounting bracket: pipe (left) and wall (right) mounting options	18
Figure 8: Pipe-mounting the DCSIU	18
Figure 9: RMU: mounting to a vertical pipe.....	19
Figure 10: RotoFlow software: UX5000 page at startup	21
Figure 11: UX5000 tab in Configure mode (for Flow, Channel 1 only)	22
Figure 12: Units tab (for single channel configuration)	24
Figure 13: Fluids tab (for single fluid configurations)	26
Figure 14: Pipes tab (for single pipe configurations)	27
Figure 15: Pipes tab: showing pipe material options	27
Figure 16: Liner(s) tab (for single pipe configurations)	28
Figure 17: Sensors tab (for single channels)	30
Figure 18: Diagnostics tab (for channel 1)	31
Figure 19: Relays/Outputs tab (for single channel use)	35
Figure 20: System/ID/RS485 tab	38
Figure 21: Configuration(s) tab (for single channel use)	41
Figure 22: Guiderail and sensor assembly	43
Figure 23: Transducer locations for Diagonal Mode	44
Figure 24: Measure mode (shown for dual channel)	46

TABLES

Table 1: Cable properties.....	13
Table 2: DCSIU connections	15
Table 3: DCSIU gland entry	17
Table 4: RotoFlow Setup Menus	22
Table 5: Unit tab options	24

1 CERTIFICATION AND COMPLIANCE

1.1 Certification and Compliance

1.1.1 EMC, Safety, Weee, RoHS

- 2014/30/EU (EMC Directive)
- EN 61326-1:2021 Electrical equipment for measurement, control and laboratory use
- 2014/35/EU (Low Voltage Directive)
- EN IEC 61010-1:2010 +A1:2016 Safety requirements for electrical equipment for measurement, control and laboratory use
- EN60529:1991+A2:2013 Degrees of Protection provided by enclosures (IP Code)
- EN60529:1989+A2:2013
- WEEE Directive 2012/19/EU
- RoHS Directive 2011/65/EU (2015/863)

1.1.2 Hazardous Area Classification ATEX, IECEx & UKEX

Directive 2014/34/EU

Directive UKSI 2016:1107

- EN IEC 60079-0:2017 Ed 7 Explosive atmospheres - Part 0: Equipment - General requirements
- EN IEC 60079-1:2014 Ed 7 Explosive atmospheres – Part 1: Equipment protection by flameproof enclosures “d”
- EN IEC 60079-11 Ed 7 Explosive atmospheres - Part 11: Equipment protection by intrinsic safety "i"

1.1.3 DCSIU Hazardous Area Label

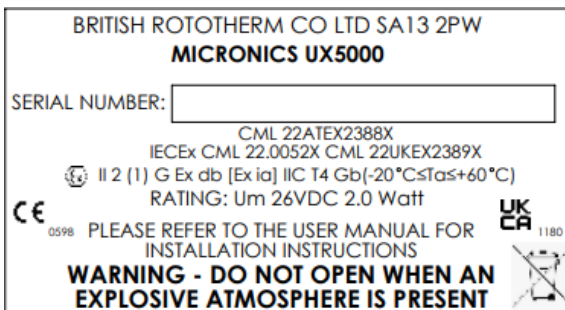

ATEX & IECEx LABEL

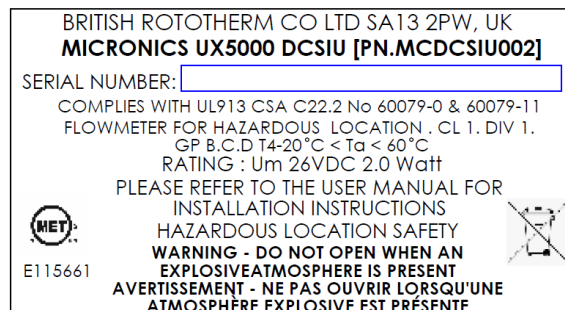

NRTL (NORTH AMERICAN) LABEL

1.1.4 RMU Hazardous Area Labels



ATEX & IECEx LABEL

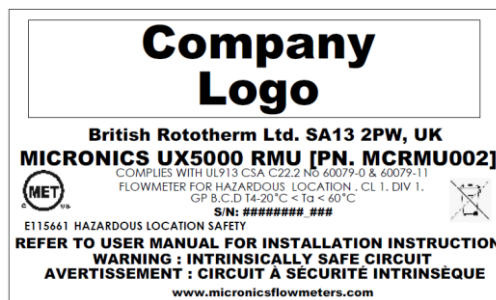

NRTL (NORTH AMERICAN) LABEL

1.1.5 Ultrasonic Flow Sensor Hazardous Area Labels

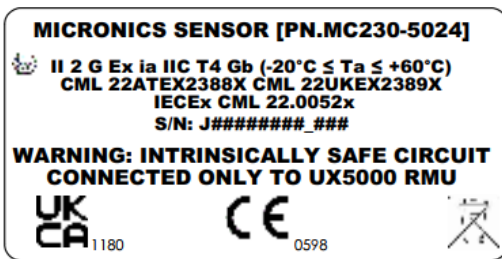

ATEX & IECEx LABEL

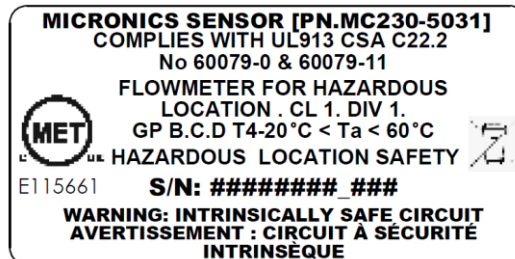

NRTL (NORTH AMERICAN) LABEL

1.2 Explanation of Symbols

	<p>Indicates separate collection for electrical and electronic Equipment (EEE).</p>		<p>Indicates that the product has been assessed to meet UK conformity to relevant legislation.</p>
	<p>Indicates explosion protection.</p>		<p>Caution when using product. Consult manufacturer's documentation before installation or use of product.</p>
	<p>Indicates that the product has been assessed to meet European conformity to relevant harmonised legislation.</p>		<p>Indicates earth ground terminal.</p>
	<p>Indicates that the product has been assessed to meet UK conformity to relevant legislation.</p>		<p>Indicates the protective grounding (earthing) terminal.</p>

1.3 Safety

1.3.1 Pre-Installation Checks

All installation activities must adhere strictly to relevant codes of practice and safety protocols, in accordance with local and national standards governing the use of electrical equipment within the specific installation location of the UX5000. Installation procedures should be entrusted solely to competent individuals.



PRIOR TO USAGE, IT IS IMPERATIVE THAT THE UX5000 HAS NO MECHANICAL DAMAGE, AND ITS CERTIFICATION MUST BE VERIFIED AS SUITABLE FOR THE INTENDED APPLICATION AND ENVIRONMENT. UNDER NO CIRCUMSTANCES SHOULD CERTIFIED EQUIPMENT BE SUBJECTED TO MODIFICATIONS.

Electrical supply connections should not be established until all installation work involving the equipment has been duly approved. Approval for readiness and compliance with certification requirements, as stated on the product label, should be granted by a competent individual. Once power is connected, refrain from disconnecting any cables from the RMU, sensors, and DCSIU on the hazardous side.

1.3.2 Specific Conditions of Use

The Micronics RMU enclosure is manufactured from aluminum. In rare cases, ignition sources due to impact and friction sparks could occur. This shall be considered during installation, particularly if the equipment is installed in a Zone 0 location.

Under certain extreme circumstances, the non-metallic parts incorporated in the enclosure of this equipment may generate an ignition capable of electrostatic charge. Therefore the equipment shall not be installed in a location where the external conditions are conducive to the build-up of electrostatic charge on such surfaces. This is particularly important if the equipment is installed in a Zone 0 location. In addition, the equipment should only be cleaned with a damp cloth.

1.3.3 Operating Environment

If the unit is exposed to direct sunlight, ensure that the resultant heat gain from radiant energy absorption does not surpass the device's maximum permissible temperature. Furthermore, precautions must be taken to prevent heat conduction from the process or ambient environment, ensuring that the UX5000 operates within the specified ambient temperature limits.

The RMU and sensors come equipped with M12 waterproof connectors, which should not be tampered with or removed. Connections should strictly adhere to the guidelines provided in this manual. Each sensor is supplied with a standard 5 meters of cable, with a maximum length of 10 meters. Sensors are connected to the RMU via this cable.

The DCSIU system will be equipped with either a line bushing or gland at the DCSIU <> RMU cable entry point, which will be sealed with a small bead of thread sealant. It is imperative that this sealant is not tampered with or loosened.

2 INTRODUCTION

2.1 General Description and Intended Use

This manual describes the installation, setup, and operation of the Micronics UX5000 ultrasonic flowmeter.

The UX5000 is a versatile and non-invasive ultrasonic transit time-based flow meter system, engineered for deployment in either Zone 1 or Zone 2 environments with potentially explosive atmospheres. It is intended to be used to measure liquid flow within closed pipes via sensors that are clamped on the exterior of the pipe within the specifications provided. This manual also provides detailed guidance on the specialized precautions required for the safe installation and utilization of the UX5000 within such hazardous atmospheres.

The system comprises a Display, Control and System Interface Unit (DCSIU) which communicates with and powers a Remote Measurement Unit (RMU) via a single cable. The DCSIU is housed in a single explosion proof enclosure and the RMU is intrinsically safe. It is imperative that the units are installed in strict compliance with local area regulations.

Please note all installation, user and maintenance instructions are to be read and followed carefully. The instrument should be used for its intended use only. If not used for intended use any damage or danger arising is at the liability of the user and will not be covered by warranty.

2.2 How Does It Work?

The UX5000 uses a cross correlation transit time algorithm to provide accurate flow measurements.

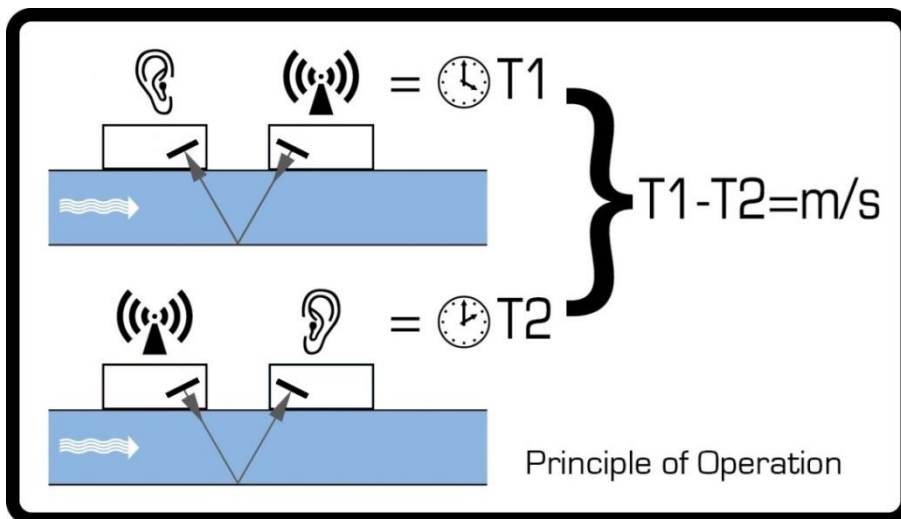

Figure 1: Principle of Transit-Time operation

An ultrasonic beam of a given frequency is generated by applying a repetitive voltage pulse to the transducer crystals. This transmission goes first from the downstream transducer to the upstream transducer as shown in the upper half of Figure 1. The transmission is then made in the reverse

direction, being sent from the upstream transducer to the downstream transducer as shown in the lower half of Figure 1. The speed at which the ultrasound is transmitted through the liquid is accelerated slightly by the velocity of the liquid through the pipe. The subsequent time difference $T1-T2$ is directly proportional to the liquid flow velocity.

The RMU operates in conjunction with one or two sets of pipe-mounted sensors.

2.3 Package Contents

The items contained in the shipping package should reach you in excellent condition. If this is not the case please do not begin installation and contact us immediately.

1. 1 x DCSIU with mount (attached)
2. 1 x DCSIU to RMU cable (10m)
3. Pipe mounting bracket
4. 1 x RMU unit with mounting kit
5. 1 x Stainless steel banding (15m)
6. 4 x Cable Ties for banding
7. 1 x Sensor Cable Red (5m)
8. 1 x Sensor Cable Blue (5m)
9. 1 x Pt100 Temperature Sensor (5m)
10. 2 x Quick Release Clamp 44-559mm
11. 2 X Quick Release Clamp 52-312mm
12. 2 X Quick Release Clamp 51- 127mm
13. 2 x Guiderail Sensor Holders
14. 2 x Sensors
15. 1 x Heatsink Compound
16. 1 x Syringe & Cap
17. 1 x Guide Rail Ruler
18. 1 x Super Lube Grease
19. 1 x Stainless Steel cable tie for Pt100

Documentation Envelope (not shown), containing:

- Calibration Certificate
- Quick Start Manual/Product Manual
- Declaration of Conformity

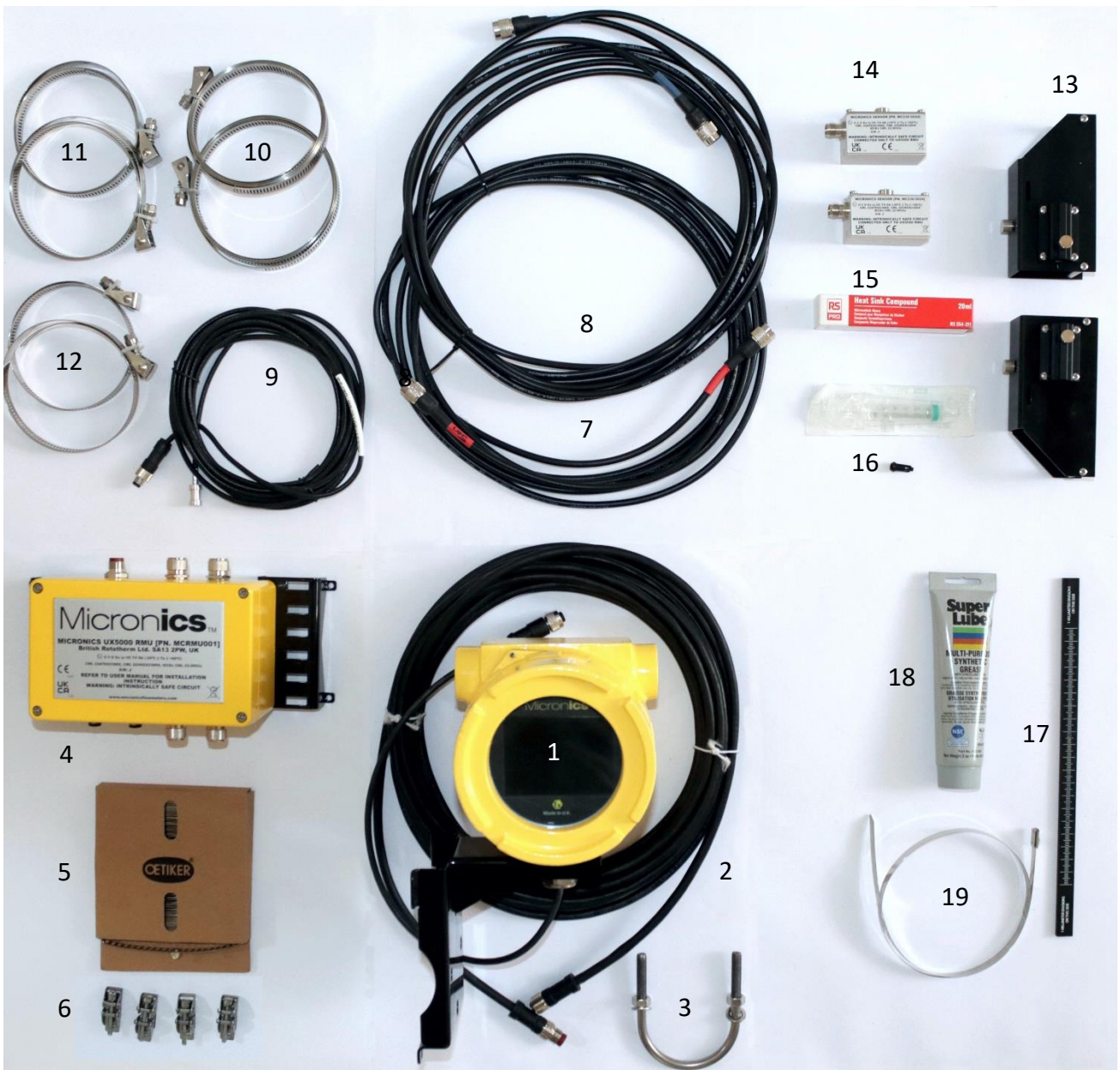

Figure 2: UX5000 Contents

2.4 System Configuration

The following diagram shows the typical configuration of a UX5000 system:

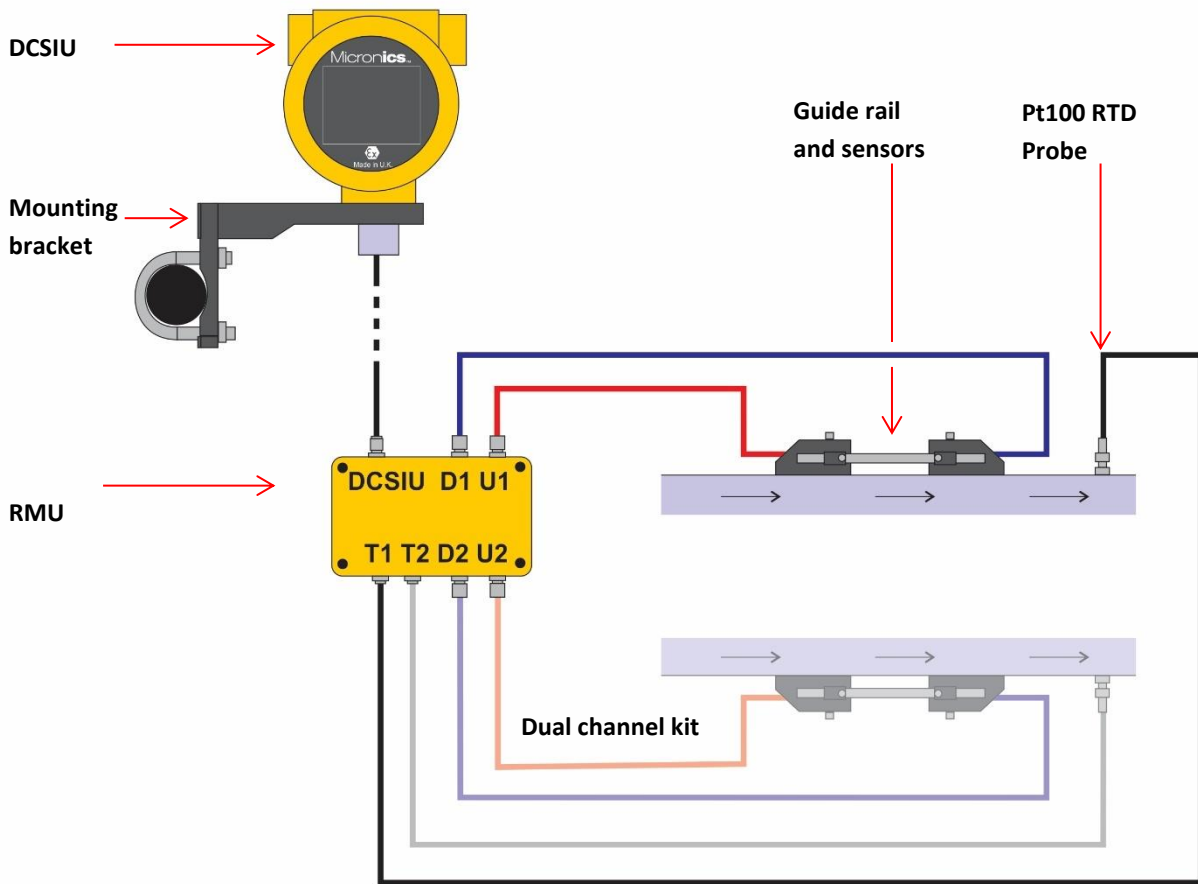

Figure 3: UX5000 system configuration

3 INSTALLATION

3.1 Unpacking

The packed unit weighs 12kg. Please handle with care and pay attention to people and equipment when transporting. The instrument should be stored or transported in its original packaging. If the instrument needs to be transported, please ensure it is adequately packed to prevent any damage to the contents or injury to personnel.

Before commencing installation inspect the instrument for any signs of damage. If any damage is present do not commence installation and contact your supplier.

3.2 Prerequisites

For installation it is recommended the following tools are available:

- Sand Paper and/or Wire Brush for Cleaning Paint or Dirt from Pipe
- 8mm Driver
- 5.5mm Flat Head Screwdriver
- ½" square head socket driver
- Electrical Screwdriver or Posidrive 0 Screwdriver
- 13mm spanner
- 1/16" Allen Key
- 3/16th Hex Allen Key
- ATEX gland ¾" NPT-14 or sue ¾"NPT to M20 x 1.5 ATEX gland adaptor
- Cable Ties
- Wire Strippers

3.3 Software Requirements

The system is configured and run from the RotoFlow application using Modbus over RS485 (PC only) or by using a Bluetooth connection (PC or tablet). Its is recommended the RotoFlow Set up program is downloaded and installed on to the intended PC or tablet before installation begins.

The RotoFlow setup program is available for download here:

<https://portal.rototechnology.com/software/rotoflow/setup.exe>

3.4 Identify Suitable Location

IMPORTANT: DO NOT EXPECT TO OBTAIN ACCURATE RESULTS IF THE SENSORS ARE POSITIONED CLOSE TO ANY OBSTRUCTION THAT DISTORTS THE UNIFORMITY OF THE FLOW PROFILE. MICRONICS LTD ACCEPTS NO RESPONSIBILITY OR LIABILITY IF PRODUCT HAS NOT BEEN INSTALLED IN ACCORDANCE WITH THESE INSTRUCTIONS.

For accurate measurements, the UX5000's guide rail and sensors must be installed at a position where the fluid flows uniformly. Flow profile distortions can result from upstream disturbance such as bends, tees, valves, pumps, and other similar obstructions. To ensure a uniform flow profile, the unit must be mounted away from any cause of flow disturbance. Avoid installing sensors in close proximity to welds or flanges. Such locations may introduce unwanted flow perturbations and compromise the accuracy of the measurement.

As a guide, we suggest this is best achieved by ensuring there is a straight length of pipe upstream of the transducers of at least 10 times the pipe diameter, and 5 times the pipe diameter on the downstream side, as shown in Figure 4, but this may vary. Flow Measurements can be made on shorter lengths of straight pipe, but when the transducers are mounted this close to any obstruction the resulting errors can be unpredictable.

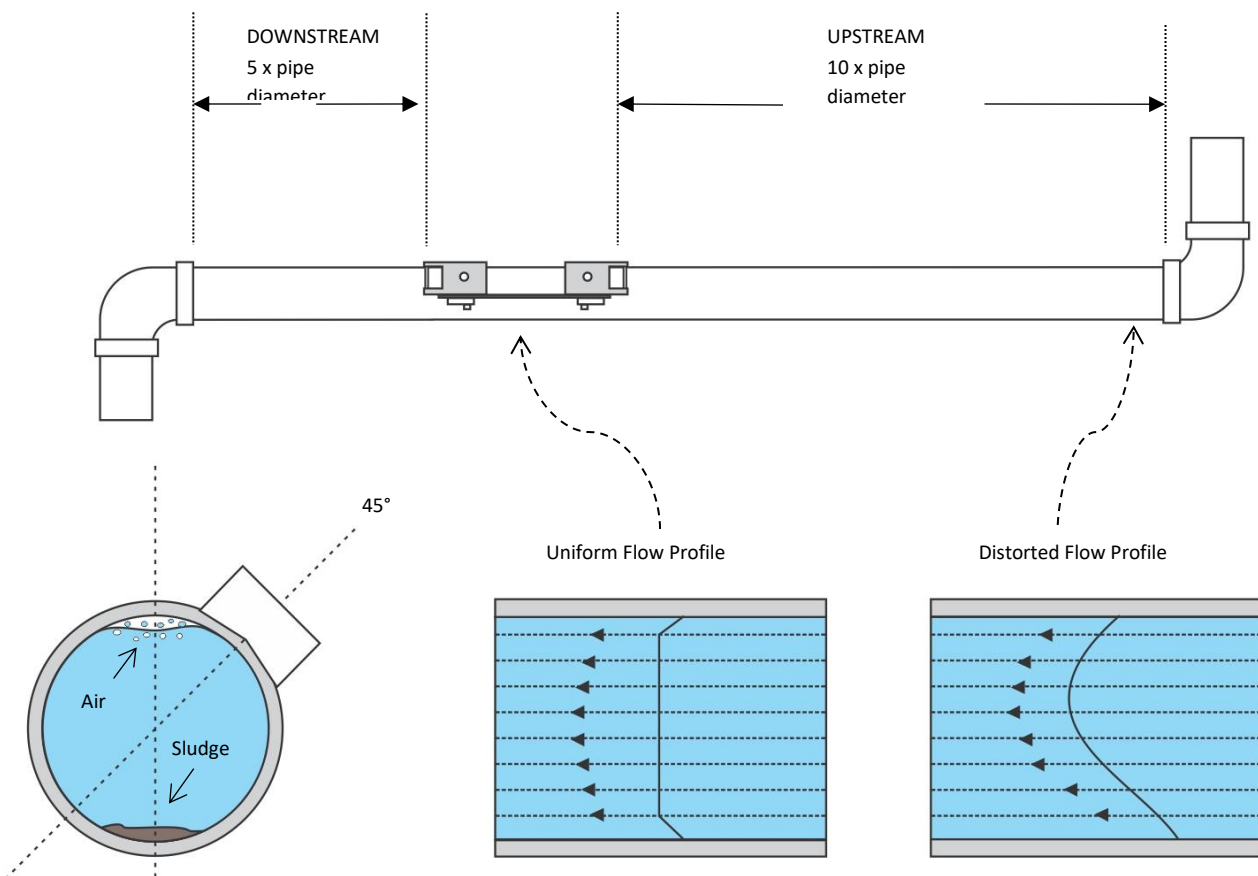

Figure 4: Location of unit

To obtain the most accurate results, the condition of both the liquid and the pipe must be suitable to allow ultrasound transmission along the predetermined path.

In many applications, an even flow velocity profile over a full 360° is unattainable due, for example, to the presence of air turbulence at the top of the flow and possibly sludge at the bottom of the pipe. Experience has shown that the most consistently accurate results are achieved when the sensors are mounted at 45° with respect to the top of the pipe.

During installation, you will need the following data:

- Pipe Material
- Pipe Inside Diameter
- Wall Thickness
- Pipe Lining Material
- Pipe Lining Thickness
- Fluid Type
- System Temperature (if not using the unit's own temperature probe(s))

3.4.1 Clean the Pipe's Flow Sensor Contact Area

Prepare the pipe by degreasing it and removing any loose material or flaking paint to obtain the best possible surface. A smooth contact between pipe surface and the face of the sensors is an important factor in achieving a good ultrasound signal strength and therefore maximum accuracy.

3.5 Power and Signal Cables

3.5.1 Field Wiring



ALWAYS UTILIZE APPROPRIATE ELECTRICAL ENTRY DEVICES, CONSIDERING FACTORS SUCH AS THE INSTALLATION ENVIRONMENT, ENCLOSURE'S IP RATING, TYPE OF PROTECTION, AND CABLE TYPE. IN POTENTIALLY EXPLOSIVE ATMOSPHERES, CERTIFIED CABLE ENTRY DEVICES ARE MANDATORY.



FLAMEPROOF CABLE ENTRY DEVICES SHOULD HOLD CERTIFICATION AS SUITABLE EX D IIC FLAMEPROOF, AND MAY BE EMPLOYED IN CONJUNCTION WITH A CERTIFIED EX D IIC FLAMEPROOF THREAD ADAPTER IF REQUIRED. ANY UNUSED ENTRIES SHOULD BE EQUIPPED WITH CERTIFIED EX D IIC FLAMEPROOF STOPPING PLUGS. IT IS IMPERATIVE THAT FLAMEPROOF CABLE ENTRY DEVICES, ADAPTERS, AND STOPPING PLUGS ARE CERTIFIED AS IIC EQUIPMENT (NOT JUST COMPONENTS) UNDER AN EC TYPE EXAMINATION CERTIFICATE.

The recommended cable is given below, in addition please ensure all work and materials are selected to meet the local standards.

Table 1: Cable properties

Property	Description	Comments
Cable	0.5mm ² / 2PR BS5308 PT1 Type 2 Collective Screen Black RP15 16 / 0.2mm ²	
Conductor Size	0.5mm ² - 16/0.2mm ² - 20AWG	
Number of Conductors	2 Pair	Number of pairs will be dependent on the IO requirements
Conductor Type	Stranded	
Material	Copper or tinned copper only	
Screen/Shield	Individual & Overall	
Construction	Foil	
Jacket Material	PVC	
Armour	Yes	Cable must be mechanically protected
Steel Wired Armour		Cable must be mechanically protected
Temperature Rating	65°C	

The RMU is powered by an intrinsically safe barrier in the DCSIU through the DCSIU<>RMU power & communication cable. The RMU and transducers are intrinsically safe and therefore require no glands. Cables for connecting the RMU and the transducers are included.



THE RMU SHOULD NEVER BE OPENED.

3.6 Opening and Closing the DCSIU Enclosure

The rear cover of the DCSIU is secured by a socket screw. Loosen, but do not remove, this screw to detach the cover for internal access. When reattaching the screw cover, ensure a smooth rotation by hand. Hand-tightening should suffice, although for added security, a tool such as the edge of a spanner may be used across the screw cover castellations. The maximum torque required should not exceed 20 Nm (15 lbf ft).

After closing, secure the screw cover in place using the socket screw.

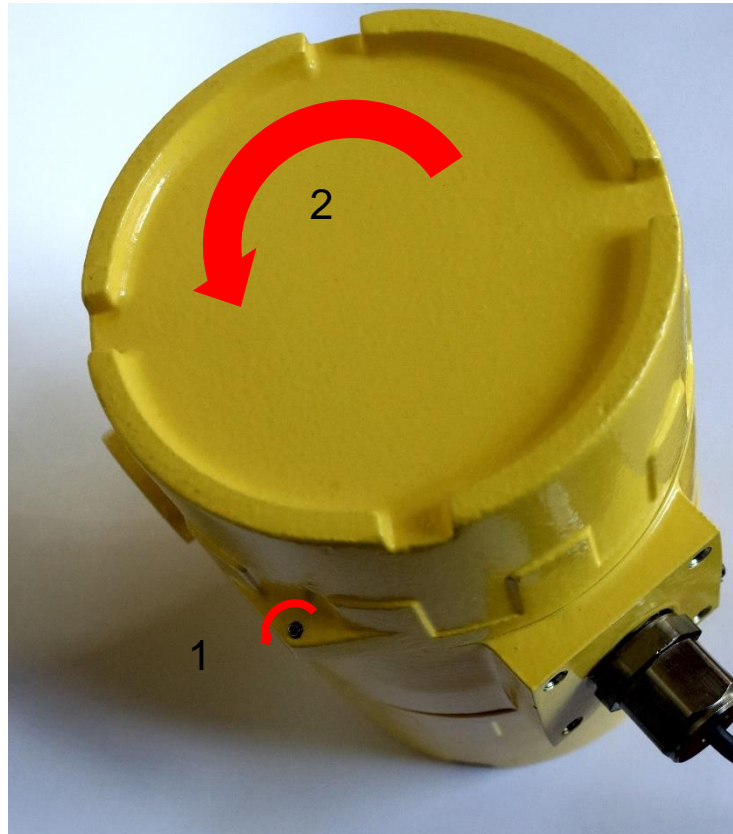

Figure 5: Removing the DCSIU cover



BOTH THE ENCLOSURE SCREW COVER AND MATING ENCLOSURE THREADS ARE PRECISELY DIMENSIONED TO MEET CERTIFICATION STANDARDS. CARE MUST BE TAKEN TO PREVENT DAMAGE TO BOTH THE COVER AND MATING THREADS WHEN SEPARATING THEM.



THE SENSOR LINE BUSHING OR GLAND MUST ALWAYS REMAIN AT THE BASE OF THE ENCLOSURE AS SUPPLIED. REMOVING THE LINE BUSHING OR GLAND MAY INVALIDATE THE HAZARDOUS AREA APPROVAL FOR THIS APPARATUS.

3.6.1 Cable Entry

The power supply cable and any optional outputs must be routed through the $\frac{3}{4}$ " NPT cabling port. Remove the blue cover to access the port.

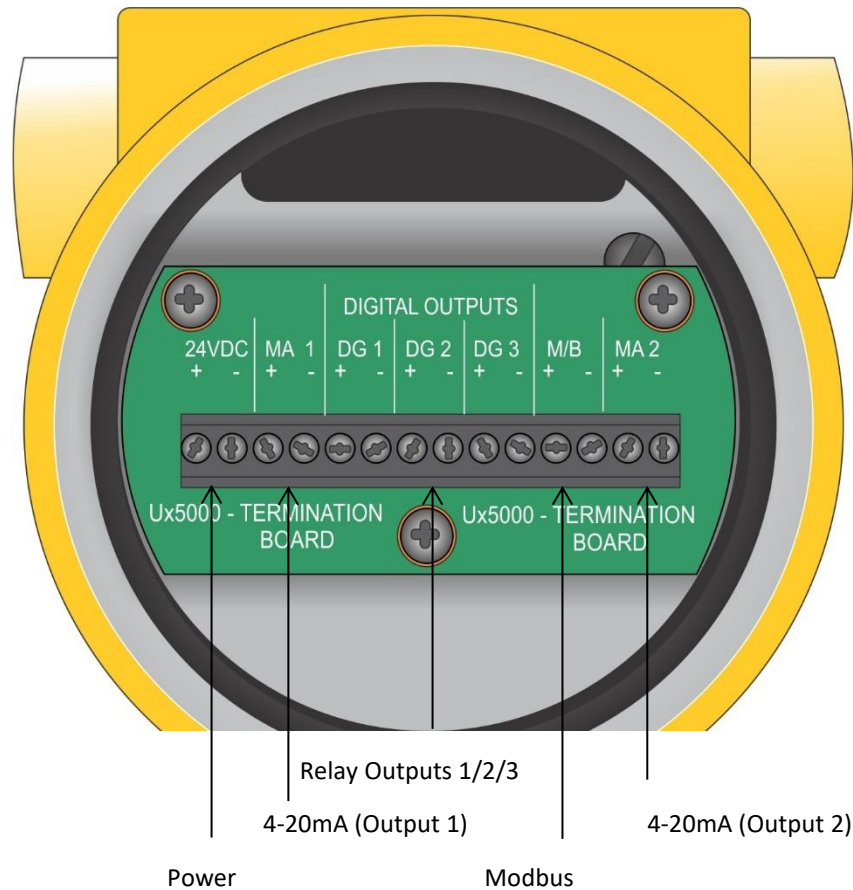

Figure 6: Terminal blocks and connectors

3.6.2 Power Supply

The DCSIU’s recommended operating voltage is between 21-24VDC. The Maximum voltage is 26V supply. It is internally protected with a 500mA 5x20 Glass Fast Acting Fuse. This in turn supplies power to the RMU through the DCSIU/RMU cable and also provides two analogue (4-20mA) outputs and 3 opto-isolated relay outputs.

NOTE: IT IS RECOMMENDED THAT THE DEVICE IS SUPPLIED VIA AN EXTERNAL FUSED ISOLATOR (1A)



-  **EXTERNAL POWER SUPPLY MUST BE CLASS 2 RATED.**
-  **THE DCSIU HOLDS FLAMEPROOF CERTIFICATION EX DB[EX IA], WHILE THE RMU (REMOTE MONITORING UNIT) AND ULTRASONIC SENSORS ARE CERTIFIED ENCAPSULATED EX IA. COMPREHENSIVE DETAILS OF THE ATEX AND IECEX CERTIFICATES CAN BE FOUND ON PAGE 1.**
-  **IT IS IMPERATIVE TO NOTE THAT POWER AND COMMUNICATION FOR THE RMU MUST ORIGINATE FROM THE DCSIU TO ENSURE ADHERENCE TO CERTIFICATION REQUIREMENTS.**

Table 2: DCSIU connections

DCSIU	RMU	Description
SUPPLY +		Power Supply + (nominal 24 VDC)
RS 485	Cable included	DCSIU (Modbus RTU control interface) cable length up to 50m (junction boxes 250 meters)
OUTPUT + (1,2)	N/A	Analogue Output + (4..20mA or 0..5V)
OUTPUT – (1,2)	N/A	Analogue Output – (4..20mA or 0..5V)
OUTPUT – (3)	N/A	3x Opto-isolated Relay outputs

3.6.3 Pulse Output Connection

The isolated pulse output (labelled PULSE-A and PULSE-B) is provided by an opto-isolated SPNO/SPNC MOSFET RELAY which has a maximum load current of 500 mA and maximum load voltage of 24 VAC when used to drive/power external equipment, and 24 VDC for Electronic Pulses / Switching.

Electrically this is a Volt/potential free contact and, when selected as a low flow alarm, is configurable NO/NC. The relay also provides isolation between the unit's electronics and external equipment.



THIS OUTPUT IS SUITABLE FOR SELV CIRCUITS ONLY

3.6.4 Current Output

The DCSIU can be optionally configured with one or two 4–20mA outputs. The isolated 4–20mA is a current source and can drive into a maximum load of 600 Ohms.

The alarm current due to a flow outside the range specified or due to a loss of signal is set at 3.5 mA.



THIS OUTPUT IS SUITABLE FOR SELV CIRCUITS ONLY

3.6.5 Modbus Connections

For detailed instructions see the separate manuals

3.6.6 Earthing

Cable drain wires must be connected to the earth screw on the base of the DCSIU enclosure. An external earth (ground) connection must be attached to the instrument enclosure, via the supplied eye crimp.

3.6.7 Gland Entries

All glanding components must meet the following requirements:

- Match enclosures flameproof certification.

- Local certification standards
- Rated for a temperature greater than 70°C
- Suitable to mate to a 3/4" NPT female thread

Table 3: DCSIU gland entry

Enclosure Style	Field Wiring (DCSIU)	RMU
Aluminium	3/4" NPT	Potted gland

3.7 Power Test

After connecting the power supply and any optional outputs, and reattaching the rear cover, test the connection by switching the power on.

As the unit initialises, make a note of the Model, Serial and Firmware numbers.

Switch the unit off again and continue with the installation.

3.8 Mounting Options



THE DCSIU IS HEAVY PLEASE HANDLE WITH CARE. USE TWO HANDS

The UX5000 DCSIU should be mounted to allow access of the field terminals and recommended at eye level to allow a clear view of the display. The enclosure is supplied with a bracket for pipe mounting or 2" pipe (stanchion) mounting or wall mounting.

3.8.1 Mounting the DCSIU

A mounting bracket is provided to allow wall or pipe mounting of the DCSIU unit.

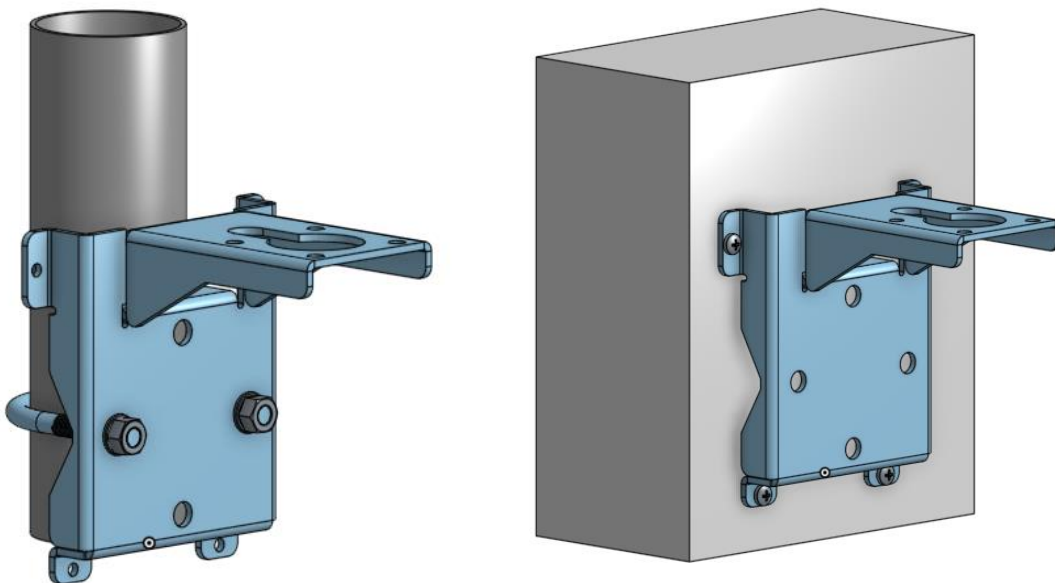

Figure 7: DCSIU Mounting bracket: pipe (left) and wall (right) mounting options

Pipe Mounting

The mounting kit includes a U-bolt, M8 washers and nuts appropriate for attaching the bracket to a horizontal or vertical 2” (60.03mm) OD pipe.

1. Identify a suitable length of vertical or horizontal 2 inch NB Pipe (1).
2. Loosely fix the DCSIU Mount Bracket (3) to the pipe (1) using the supplied U-Bolt (2), Washers (4) and Nuts (5).
3. Clamp the DCSIU Mount Bracket orientated in the required position by tightening each Nut (5) equally in turn.

1	2 inch Nb pipe (60.3mm od)
2	'U' Bolt
3	DCSIU Mount Bracket
4	M8 Washer
5	M8 Full Nut

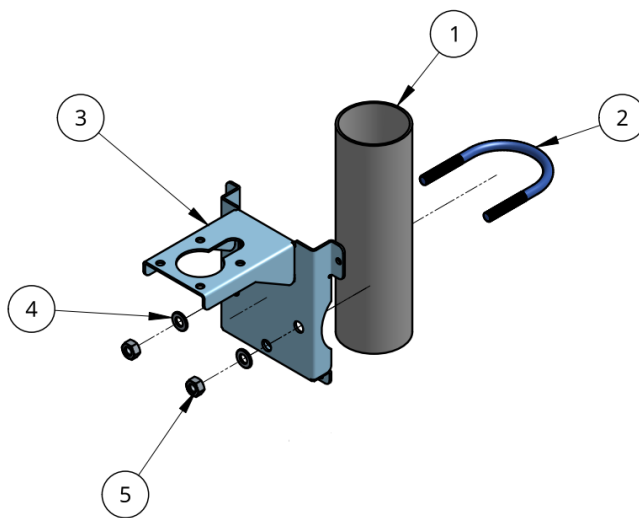

Figure 8: Pipe-mounting the DCSIU

Wall Mounting

If wall mounted, the DCSIU should be mounted as follows:

- Solid wall with 4 x 5mm / #10 screw and appropriate Wall Plugs
- Timber frame with 4 x 5mm / #10 screws
- Metal framework with 4 x M5 Machine Bolts

The mounting bracket should be attached by the four side tabs (as shown in Figure 7) using appropriate fittings (not provided).

3.8.2 Mounting the RMU

The RMU can be wall or pipe mounted.

PLEASE NOTE THE DISTANCE BETWEEN THE INSTALLED RMU AND DCSIU IS LIMITED BY THE LENGTH OF THE DCSIU TO RMU CABLE SUPPLIED (10M STANDARD). THE DISTANCE BETWEEN THE

INSTALLED RMU AND PIPE ON WHICH THE SENSORS WILL BE FITTED WILL BE LIMITED BY THE LENGTH OF THE SENSOR CABLES (5M STANDARD)

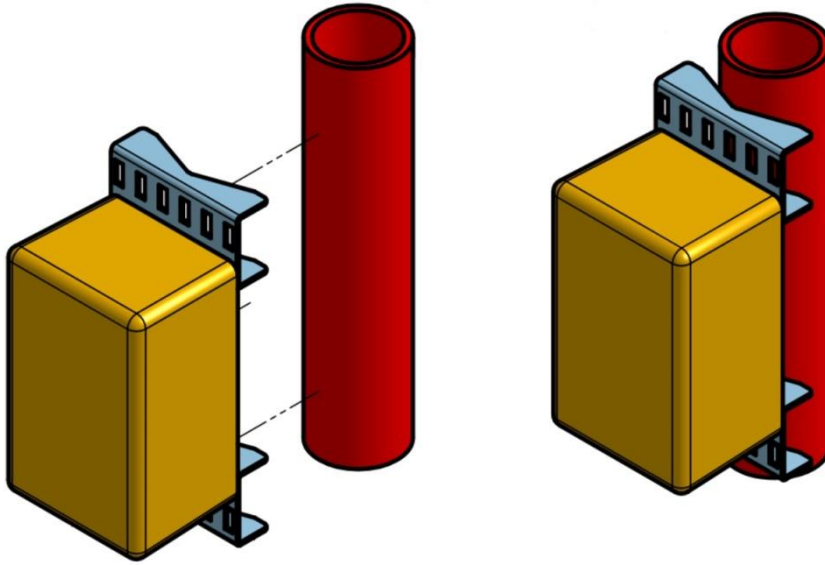

Figure 9: RMU: mounting to a vertical pipe

Pipe Mounting

The RMU can be attached to a horizontal or vertical pipe with a diameter between 25mm (1") and 180mm (7"). Use suitable band clamps (quick release clamps or stainless steel banding) threaded through the slotted brackets at each end of the unit. Follow the manufacturer's instructions when using clamps for this purpose.

Wall Mounting

It is also possible to mount the unit on a wall using appropriate fastenings (not supplied) applied to the slotted brackets.

The DCSIU connects to the RMU via the DCSIU/RMU cable, please note the cable is keyed, do not force connection.



PLEASE NOTE THAT IF THE EQUIPMENT IS USED IN A MANNER OTHER THAN THE INTENDED USE THE PROTECTION PROVIDED BY THE EQUIPMENT MAY IMPAIRED.



PLEASE NOTE THAT THE EQUIPMENT IS INTENDED TO BE USED WITHIN THE ENVIRONMENTAL SPECIFICATIONS AS DENOTED ON LABELLING. TEMPERATURES SHOULD NOT EXCEED LIMITS OF -20°C AND +60°C. IF INSTRUMENT IS USED IN ENVIRONMENTS NOT SPECIFIED BY LABELLING THE PROTECTION PROVIDED MAY BE IMPAIRED.

4 SOFTWARE CONFIGURATION

4.1 Software Installation

The system is configured and run using the RotoFlow application using Modbus over RS-485 (PC only) or by using a Bluetooth connection (PC or tablet).

Download the RotoFlow setup program here:

<https://portal.rototechnology.com/software/rotoflow/setup.exe>

Follow the on-screen instructions to install and run the program.

MODBus Connection:

1. Connect your PC to the DCSIU using the RS485 serial terminal.
2. Click on the **Find Ports** button located at the top left-hand corner of the program.
3. From the drop-down list, select the appropriate **Coms Port**.
4. Click on the **Connect** button.
5. Choose the **Modbus ID** from the scroll list.
6. Click on the **Start** button for communications.

Bluetooth Connection:

1. Click on the **Bluetooth** tab.
2. Search for devices and select **UX5000**.
3. Once connected, press the **Start** button.

A flashing green status indicator confirms a successful connection. A flashing red indicator indicates failure to establish a connection.

PLEASE ENSURE THAT COMPUTER DISPLAY SETTINGS HAVE THE VIEWING SCALE SET TO 100%. CHECK THIS BY GOING TO DISPLAY SETTINGS > SCALE & LAYOUT > SCALE TO 100%. REMEMBER TO SAVE THE NEW SETTING.

4.2 UX5000 tab

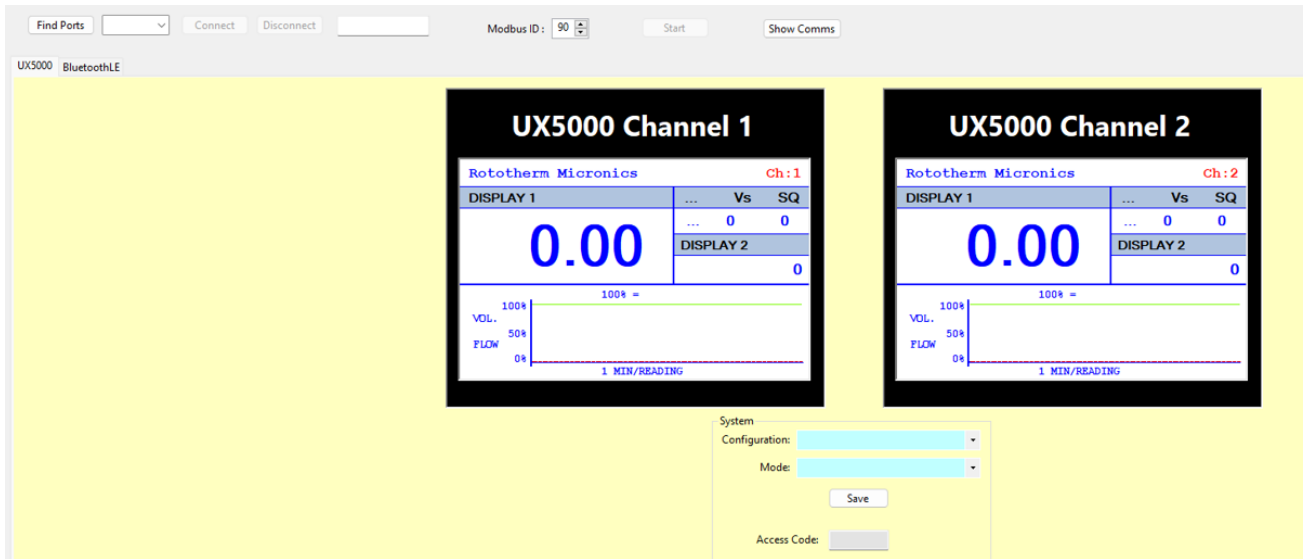

Figure 10: RotoFlow software: UX5000 page at startup

The UX5000 page has *Configure* and *Measure* modes. In *Configure* mode, the settings for each channel are displayed in several tabbed pages.

To enter this mode, you need to choose the configuration unit setup.

1. In the *System* group box, select one of the following options from the **Configuration** dropdown list:
 - **Flow, Channel 1 only:** This configuration means that the flow measurement is being taken solely from Channel 1 of the metering device. Only the flow data from Channel 1 will be considered for analysis or monitoring.
 - **Flow, Channel 2 only:** Similar to the previous configuration, but in this case, only the flow data from Channel 2 is being utilized for measurement and monitoring purposes.
 - **Flow, Channels 1&2 on 2 pipes:** This configuration suggests that the flow measurements from both Channel 1 and Channel 2 are being used, and they are applied to monitor the flow in two separate pipes. Each channel's data corresponds to a different pipe.
 - **Flow, Channels 1&2 on 1 pipe:** Here, both Channel 1 and Channel 2 are employed for flow measurement, but they are both applied to monitor the flow in a single pipe. This could be useful for redundancy or for monitoring different aspects of flow within the same pipe.
2. From the Mode drop-down list, choose **Configure**.
3. In the Access Code box, enter **17360**.

- Click on the **Save** button to confirm the selections.

Settings for the chosen configuration are now displayed on a series of tabbed pages.

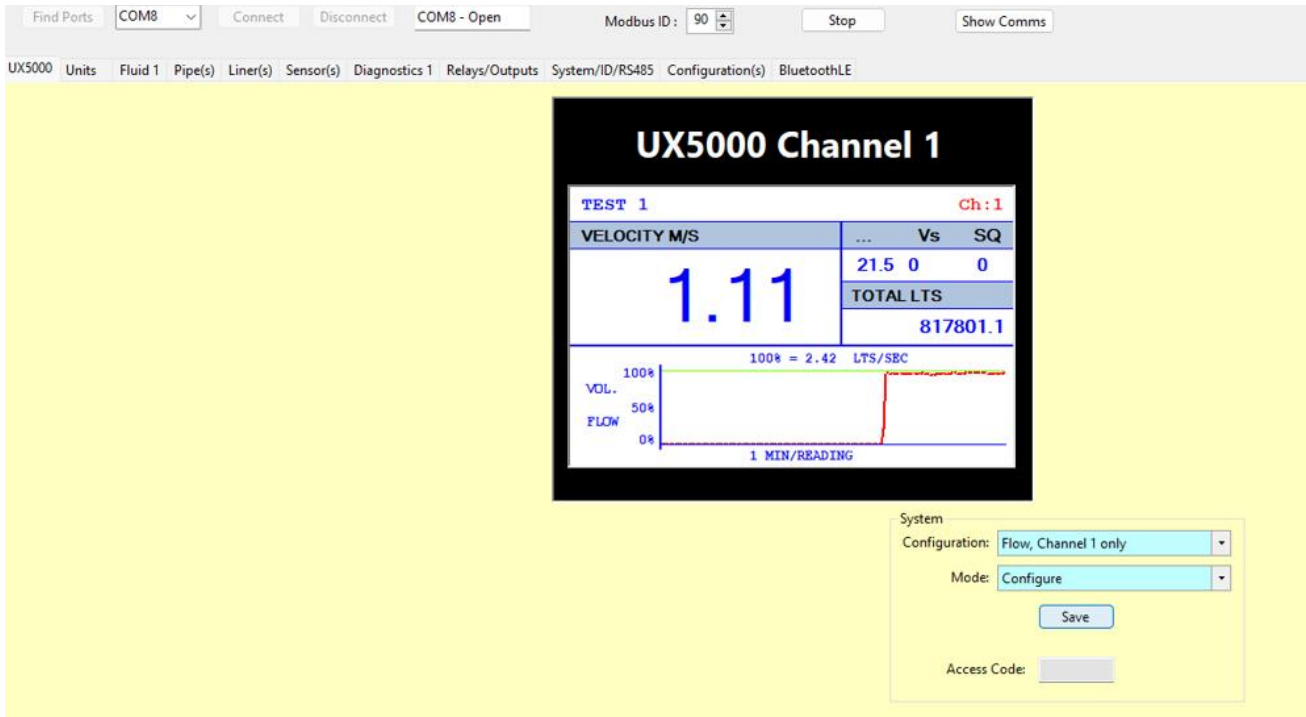

Figure 11: UX5000 tab in Configure mode (for Flow, Channel 1 only)

Table 4: RotoFlow Setup Menus

Menu	Description
Units	Select units of measurement displayed in <i>Measure</i> mode: temperature, length, flow velocity, mass, flow volume and total volume.
Fluid 1	Identify characteristics of fluid in pipe. Select standard fluid, such as water, or enter speed of sound, viscosity and density coefficients.
Fluid 2 (dual channel system only)	
Pipe(s)	Enter diameter and wall thickness of pipe(s).
Liner(s)	Enter material and thickness of pipe liner.
Sensor(s)	Identify the type of temperature sensor in use.
Diagnostics 1	Parameters - View readings obtained from the unit's sensors including the correct separation distance for the flow sensors. Diagnostics - System performance and troubleshooting information
Diagnostics 2 (dual channel system only)	
Relays/Outputs	Set options for relay outputs and analogue outputs.

System/ID/RS485	System information.
Configuration(s)	System settings.
Bluetooth LE	

4.3 Units tab

The Units tab allows you to select display units according to your preference. Below are the available options for unit selection.

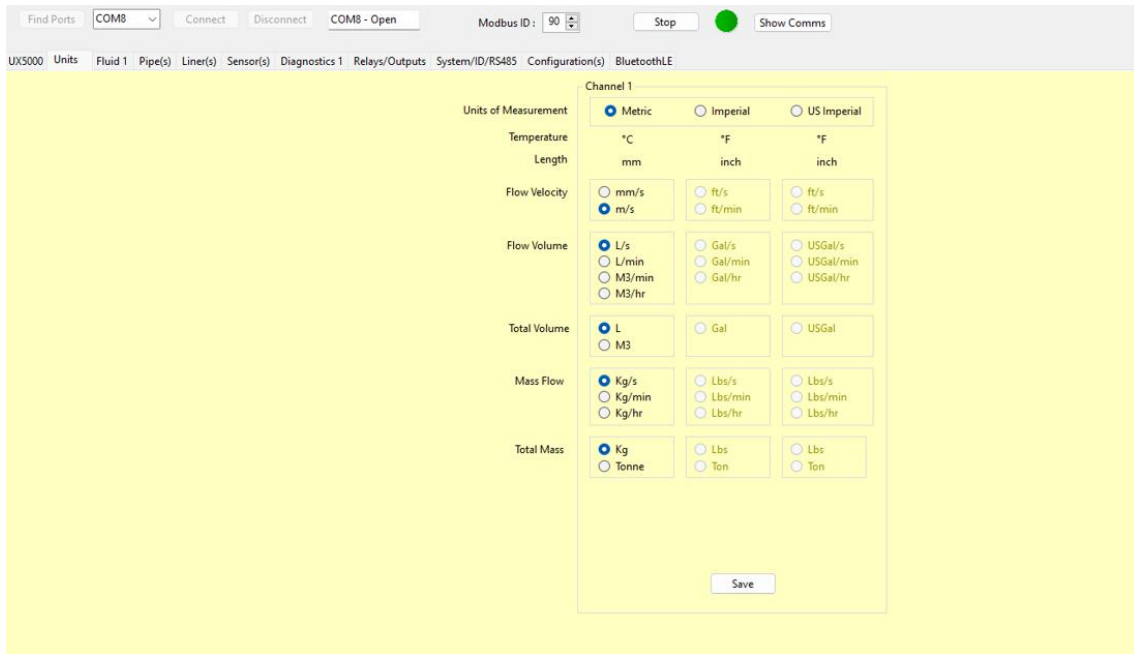

Figure 12: Units tab (for single channel configuration)

Table 5: Unit tab options

Units of Measurement	Metric	Imperial	US Imperial
Temperature	Celsius (°C)	Fahrenheit (°F)	Fahrenheit (°F)
Length	millimetre (mm)	inch	inch
Flow Velocity	millimetre/sec (mm/s) Metres per second (m/s)	feet per second (ft/s) feet per minute (ft/min)	feet per second (ft/s) feet per minute (ft/min)
Flow Volume	litres per second (l/s) litres per minute (l/min) cubic metres per minute (m ³ /min) cubic metres per hour	gallons per second (gal/s) gallons per minute (gal/min) gallons per hour (gal/hour)	US gallons per second (USgal/s) US gallons per minute (USgal/min) US gallons per hour (USgal/hour)

Units of Measurement	Metric	Imperial	US Imperial
	(m ³ /hour)		
Total Volume	Litres (l) Cubic metres (m ³)	gallons (gal)	US gallons (USgal)
Mass Flow	kilograms per second (kg/s) kilograms per minute (kg/min) kilograms per hour (kg/hr)	pounds per second (lbs/s) pounds per minute (lbs/min) pounds per hour (lbs/hr)	pounds per second (lbs/s) pounds per minute (lbs/min) pounds per hour (lbs/hr)
Total Mass	kilograms tonne	pounds (lbs) ton	pounds (lbs) ton

4.4 Fluid 1/2 tab

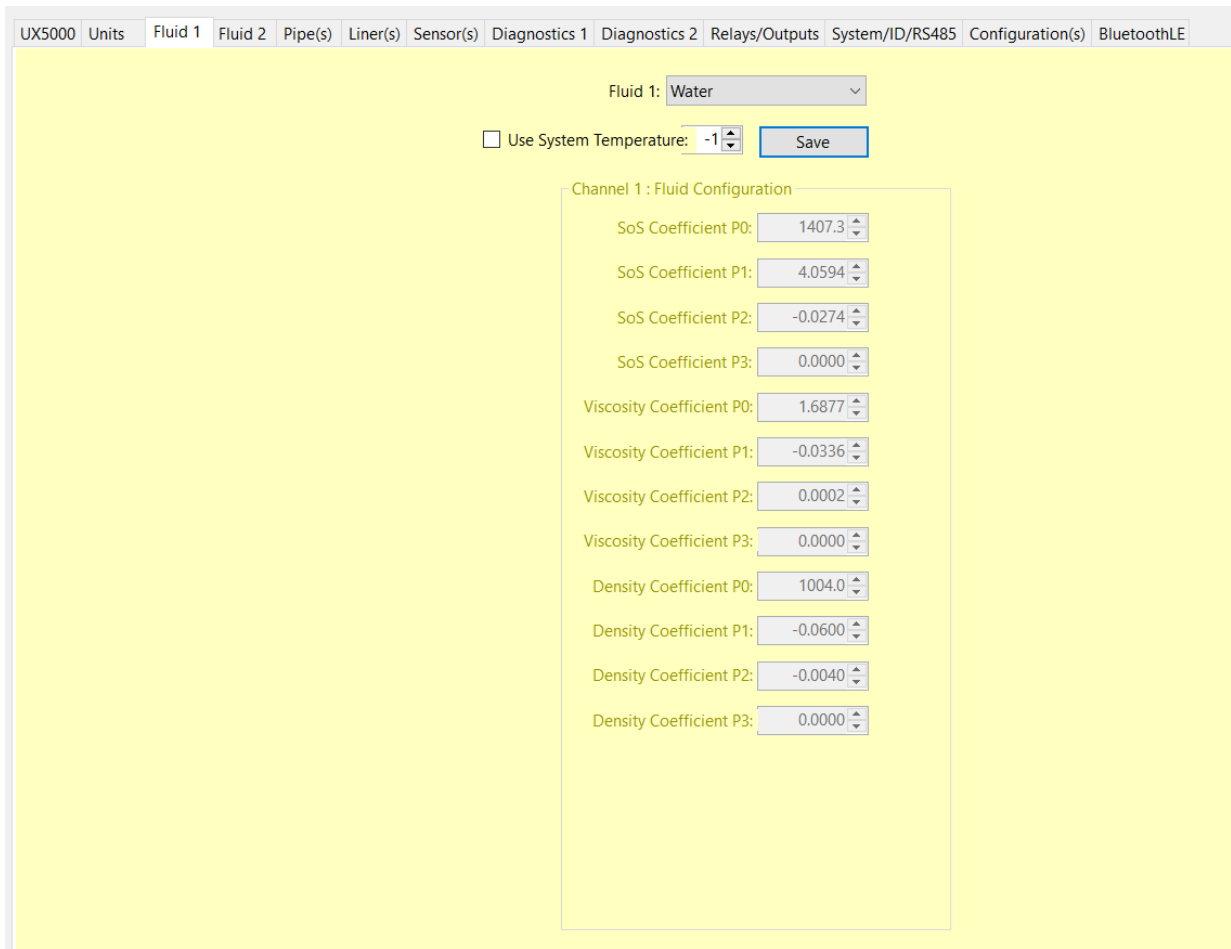

Figure 13: Fluids tab (for single fluid configurations)

4.4.1 Application Temperature

Use System Temperature:

You have the flexibility to input the application temperature manually or utilize the system temperature using a PT100 Temperature sensor. This sensor enables dynamic flow reading and ensures a more accurate setup based on real-time temperature data.

4.4.2 Fluid Selection

Select the fluid type from the drop down menu options:

- **Other:** allows for the specification of custom liquid parameters based on the fluid configuration options described below:

4.4.3 Fluid Configuration Options

- **SOS Coefficient P0:** Speed of Sound (SOS) coefficient - Polynomial 0.
- **SOS Coefficient P1:** Speed of Sound (SOS) coefficient - Polynomial 1.
- **SOS Coefficient P2:** Speed of Sound (SOS) coefficient - Polynomial 2.
- **SOS Coefficient P3:** Speed of Sound (SOS) coefficient - Polynomial 3.
- **Viscosity Coefficient P0:** Viscosity coefficient - Polynomial 0.
- **Viscosity Coefficient P1:** Viscosity coefficient - Polynomial 1.
- **Viscosity Coefficient P2:** Viscosity coefficient - Polynomial 2.
- **Viscosity Coefficient P3:** Viscosity coefficient - Polynomial 3.
- **Density Coefficient P0:** Density coefficient - Polynomial 0.
- **Density Coefficient P1:** Density coefficient - Polynomial 1.
- **Density Coefficient P2:** Density coefficient - Polynomial 2.
- **Density Coefficient P3:** Density coefficient - Polynomial 3.

NOTE: WHEN SELECTING THE FLUID TYPE, ENSURE COMPATIBILITY WITH THE FLUID CONFIGURATION OPTIONS. FOR EXAMPLE, IF YOU CHOOSE A SINGLE-CHANNEL CONFIGURATION, ONLY ONE FLUID OPTION IS APPLICABLE. IF YOU SELECT A DUAL-CHANNEL CONFIGURATION, AN OPTION FOR THE SECOND FLUID MAY BE AVAILABLE.

Once your choice has been selected, remember to press "Save" to apply the changes.

4.5 Pipe(s) tab

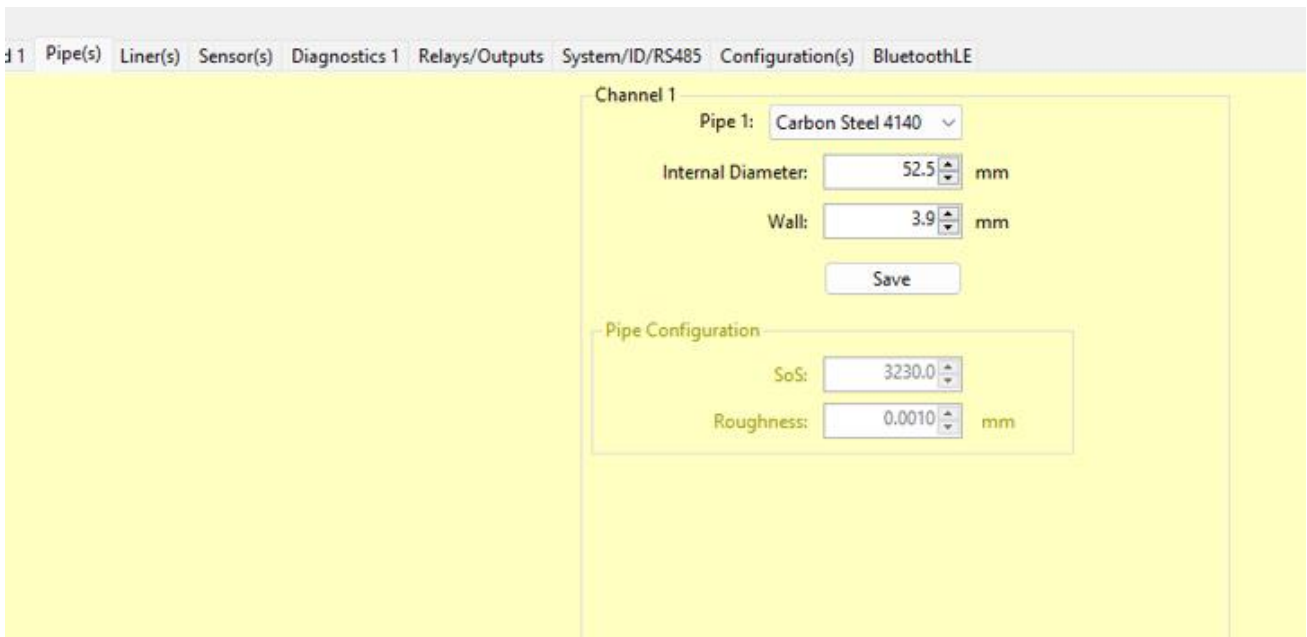

Figure 14: Pipes tab (for single pipe configurations)

4.5.1 Pipe Selection Section

In this section, you will select the appropriate options for the pipe(s) based on your specific requirements. The options may vary depending on whether you are configuring a single channel (Pipe 1) or a dual channel/dual path setup (which will include Pipe 2).

4.5.2 Pipe Material

Select the material of the pipe(s) from the drop-down list. The pipe configuration data will be automatically updated based on your selection, except for the "Other" option, which will require manual input of the pipe configuration.

If you choose *Other*, please provide manual input for the pipe configuration.

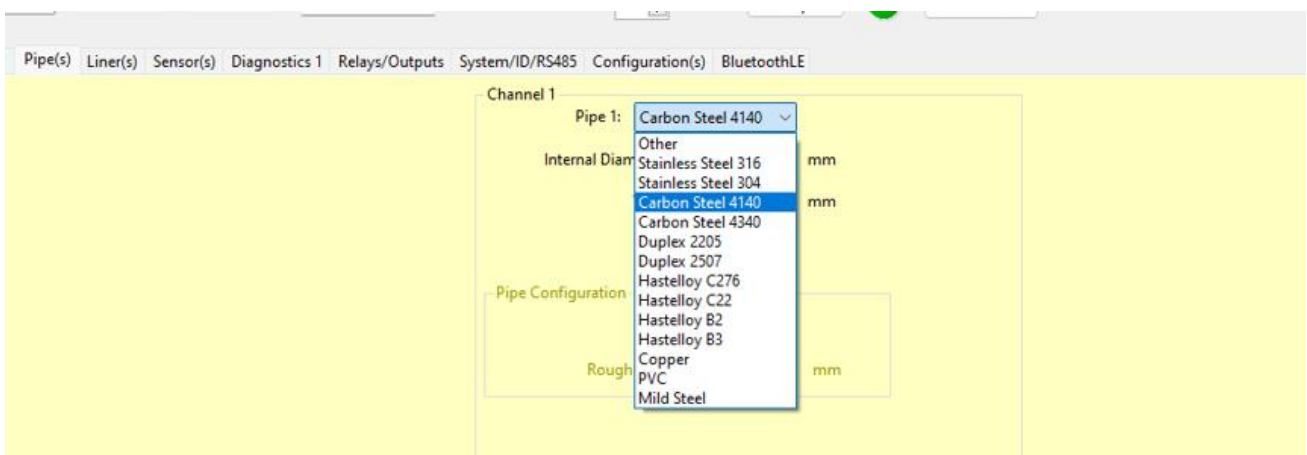

Figure 15: Pipes tab: showing pipe material options

4.5.3 Manual Inputs

For accurate configuration, manual inputs are required for the following parameters:

- **Internal Diameter**

Measure the inner diameter of the pipe using an appropriate measuring tool or obtain from the pipe datasheet. This measurement is crucial for accurate flow calculations.

- **Units**

Ensure that the units for the measurements (internal diameter, and wall thickness) reflect those selected in the **Units** tab for consistency and accuracy.

4.5.4 Pipe Configuration Option

- **SoS (Speed of Sound)**

This parameter indicates the speed of sound through the pipe wall.

- **Roughness**

This refers to the surface roughness of the pipe's interior. It affects the flow of the medium within the pipe. For non-invasive ultrasonic metering, understanding the pipe's roughness is crucial for accurate measurements.

Select appropriate values for SoS and Roughness based on your specific requirements and the nature of the fluid being measured.

Once your choice has been selected, remember to click on **Save** to apply the changes.

4.6 Liner(s) tab

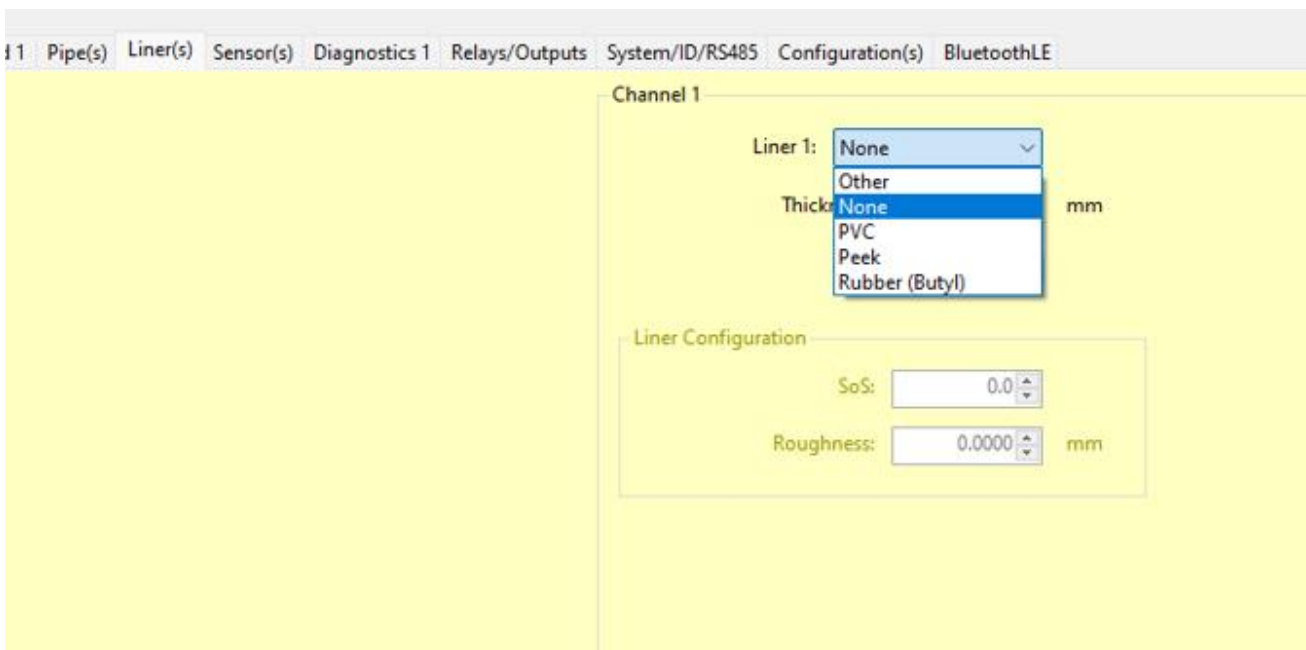

Figure 16: Liner(s) tab (for single pipe configurations)

4.6.1 Liner Options

The system offers various liner options to accommodate diverse applications. Each liner type possesses unique characteristics suited to different operational requirements:

- **PVC**
PVC liners provide a cost-effective solution with excellent chemical resistance and flexibility. They are suitable for applications where corrosion protection and ease of installation are paramount.
- **Peek**
PEEK liners offer superior chemical resistance and thermal stability, making them suitable for demanding environments involving aggressive chemicals or high temperatures.
- **Rubber (Butyl)**
Butyl rubber liners exhibit exceptional elasticity and resilience, offering reliable sealing properties and resistance to abrasion. They are commonly used in applications requiring a flexible and durable lining material.
- **Other**
The "Other" option allows for flexibility in selecting a liner material not listed above. You can specify a preferred liner material manually, ensuring compatibility with unique application requirements. This option serves as the default choice when no specific liner is selected from the dropdown list

4.6.2 Thickness

Enter the thickness of the liner in the displayed units.

4.6.3 Liner Configuration

- **SoS (Speed of Sound)**
This parameter indicates the speed of sound through the liner material.
- **Roughness**
This refers to the surface roughness of the liner's interior. It affects the flow of the medium within the pipe. For non-invasive ultrasonic metering, understanding the pipe's roughness is crucial for accurate measurements.

Select appropriate values for SoS and Roughness based on your specific requirements and the nature of the fluid being measured.

By understanding the significance of liner configuration and selecting the appropriate liner type and specifications, you can optimize the performance and longevity of the system while meeting the demands of their specific applications.

Once your choice has been selected, remember to click on **Save** to apply the changes.

4.7 Sensor(s) tab

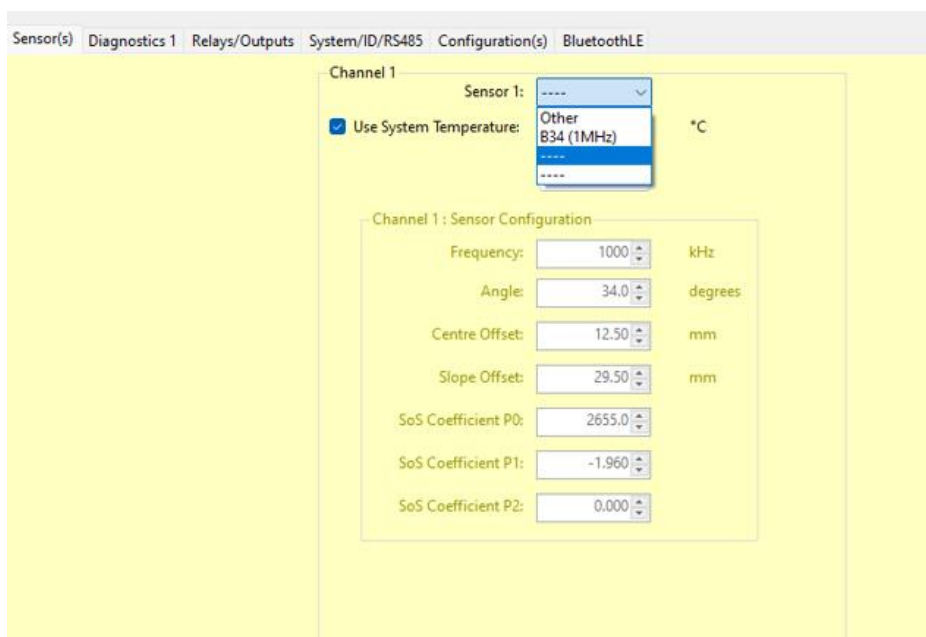

Figure 17: Sensors tab (for single channels)

Single Channel Sensor Selection

For a single channel setup, Sensor 1 is recommended.

Dual Path/Dual Channel Sensor Selection

For a dual path or dual channel setup, Sensor 1 & Sensor 2 is required.

Once your choice has been selected, remember to click on **Save** to apply the changes.

4.8 Diagnostics tab

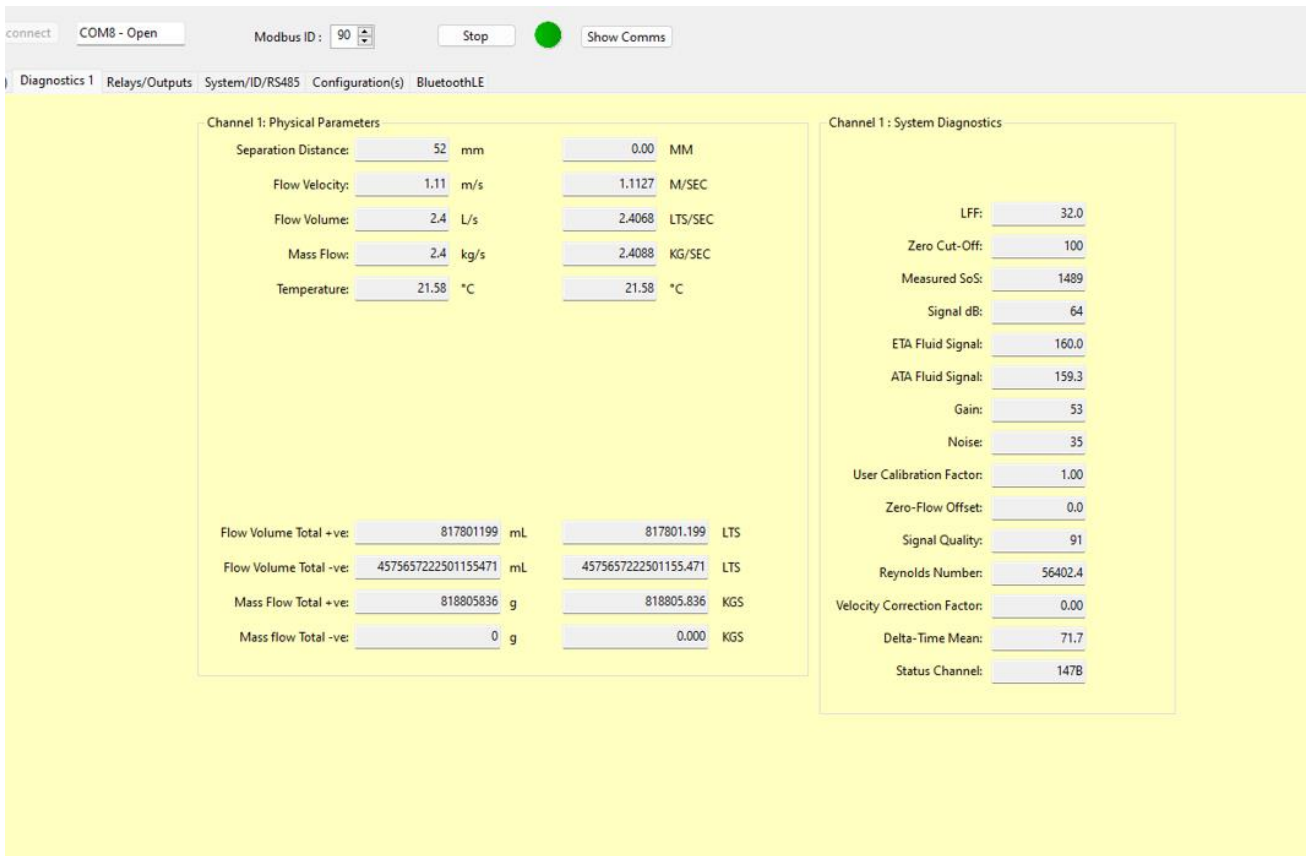

Figure 18: Diagnostics tab (for channel 1)

This section is designed for viewing purposes only.

The Physical Parameters Tab the parameters displayed represent the readings obtained directly from the unit's sensors. These readings are presented in the units selected in the "Unit Selection" interface (3.5.2.1).

The System Diagnostics Tab provides insights into the system's performance and health to effectively monitor and troubleshoot the flow metering system.

4.8.1 Physical Parameters

- **Separation Distance**

The separation distance is the distance required between the two sensor faces to ensure correct signal detection.

IMPORTANT: MAKE A NOTE OF THIS VALUE AND APPLY IT TO THE GUIDERAIL DURING ASSEMBLY (SEE PAGE 43). PROPER SENSOR SEPARATION IS CRUCIAL FOR ACCURATE FLOW MEASUREMENTS AS IT AFFECTS THE SENSOR'S ABILITY TO DETECT FLOW DISTURBANCES.

- **Flow Velocity**

The rate at which fluid flows past a given point in the system. It is expressed in units such as

meters per second (m/s) or feet per second (ft/s) and provides crucial information about the flow dynamics.

- **Flow Volume**

The volume of fluid passing through a specified point in the system over a certain period. It is typically measured in units like cubic meters (m³) or gallons (gal) and helps in quantifying the amount of fluid movement.

- **Mass Flow**

The rate at which mass (or weight) of fluid passes through a particular point in the system. It is often measured in units like kilograms per second (kg/s) or pounds per hour (lb/hr) and is significant for applications where mass is more relevant than volume.

- **Temperature**

The degree of hotness or coldness measured in the system. It is a crucial parameter influencing the behaviour of fluids and materials within the system. Temperature is commonly measured in degrees Celsius (°C) or Fahrenheit (°F).

- **Flow Volume Total +ve**

The total cumulative volume of fluid flow in the positive direction since the start of monitoring. It provides an accumulated measure of fluid flow in the system's desired direction.

- **Flow Volume Total –ve**

The total cumulative volume of fluid flow in the negative direction since the start of monitoring. It offers an accumulated measure of fluid flow in the opposite direction to the system's desired flow.

- **Mass Flow Total +ve**

The total cumulative mass flow in the positive direction since the beginning of monitoring. It presents an accumulated measure of mass flow aligned with the system's intended direction.

- **Mass Flow Total –ve**

The total cumulative mass flow in the negative direction since the commencement of monitoring. It illustrates an accumulated measure of mass flow opposing the system's desired flow direction.

4.8.2 System Diagnostics

The values displayed in the **Diagnostics** tab provide a summary of system calculations, settings, and user inputs.

LFF (Linear-Flow Factor)

The LFF is a conversion factor calculated from the fluid parameters and the system geometry. It converts the time difference between the upstream and downstream signals to a flow velocity.

It allows advanced users to quickly identify anomalies in set-up parameters.

Typical values

2-inch pipe, double reflex mode, water : 30ns/m/s

4-inch pipe, single reflex mode, water: 30ns/m/s

12-inch pipe, single reflex mode, water: 90ns/m/s

Zero Cut-Off

The Zero Cut-off is a velocity (mm/s) entered by the user to set the flow velocity, below which, the meter will read zero. This prevents the meter from displaying 'noise' at low / zero flow values.

If a value of zero (the default setting) is entered, the meter automatically sets a calculated value based on the set-up parameters.

Typical values::

2-inch pipe, water : 100mm/s

4-inch pipe, water: 50mm/s

12-inch pipe, water: 25mm/s

Measured SoS

This is the value of fluid speed of sound calculated by system measurements and set-up parameters. It provides a quick check of correct system operation.

Typical value: Water: 1420 – 1557 m/s

Signal dB

This is the measured signal level of the processed received signal converted in to decibels. If the system is operating correctly the value should be almost constant.

Typical value: 63-65dB

ETA Fluid Signal

This value is the estimated time for the ultrasonic pulse to travel between the transmitting and receiving sensors. It is calculated from fluid parameters, system geometry and signal mode. It provides a quick confirmation of set-up parameters.

Typical values:

2-inch pipe, double reflex mode, water : 160us

4-inch pipe, single reflex mode, water: 160us

12-inch pipe, single reflex mode, water: 450us

ATA Fluid Signal

This value is the measured time taken for the ultrasonic pulse to travel between the transmitting and receiving sensors. It can be compared with the ETA to confirm correct system set-up and operation.

Typical value should be within a few microseconds of the ETA value.

Gain

This is the measured value of the receiver amplifier gain required to achieve a received signal level suitable for processing. The value is represented in decibels. The value depends on the pipe material, fluid type, signal mode and installation quality.

Typical value: 20-50dB

Noise

This is the measured value of received signal noise represented in decibels.

Typical value: 10-30dB

User Calibration Factor

Not routinely used and uses the default value of one. This input allows the user to enter a value to adjust the meter reading by a fixed factor.

Typical value: 0.95 – 1.05

Zero-Flow Offset

This input allows the user to 'zero-out' the small offset inherent in the system installation. The offset may be calculated by setting the flow rate to zero, setting the Zero Cut-off value to 1mm/s, and averaging several delta-time readings. Setting the zero-flow offset greatly improves system accuracy at low flow rates.

NOTE: OFFSETS GREATER THAN 1ns MAY BE AN INDICATION OF INCORRECT SENSOR INSTALLATION.

Typical value: +/-500ps

Signal Quality

This figure is calculated using signal gain, signal to noise ratio, and ETA / ATA time difference. A value above 60 shows adequate system performance.

Typical value: 60 - 100

Reynolds Number

The calculated value of Reynold Number used in velocity correction calculations.

Typical value: 10000 - 500000

Velocity Correction Factor

This value is the calculated correction factor applied to the fluid flow velocity calculations.

Typical Value: 0.93 – 0.99

Delta-Time Mean

The Delta-Time value is the measured value between the upstream and downstream ultrasonic signal transit times.

Typical value: ± 0 – 250ns

Status Channel

This value indicates the current operating status of the meter.

Typical values:

Status: 0 – No errors

- Bit 0: No signal
- Bit 1: Flow engine calculation error
- Bit 2: Memory comms error
- Bit 3: Flow engine comms error
- Bit 4: RTD error
- Bit 5: Configuration error
- Bits 6-15: Reserved

4.9 Relays/Outputs tab

This tabbed page outlines various configurations and options for relay outputs and analogue outputs in the context of flow metering systems.

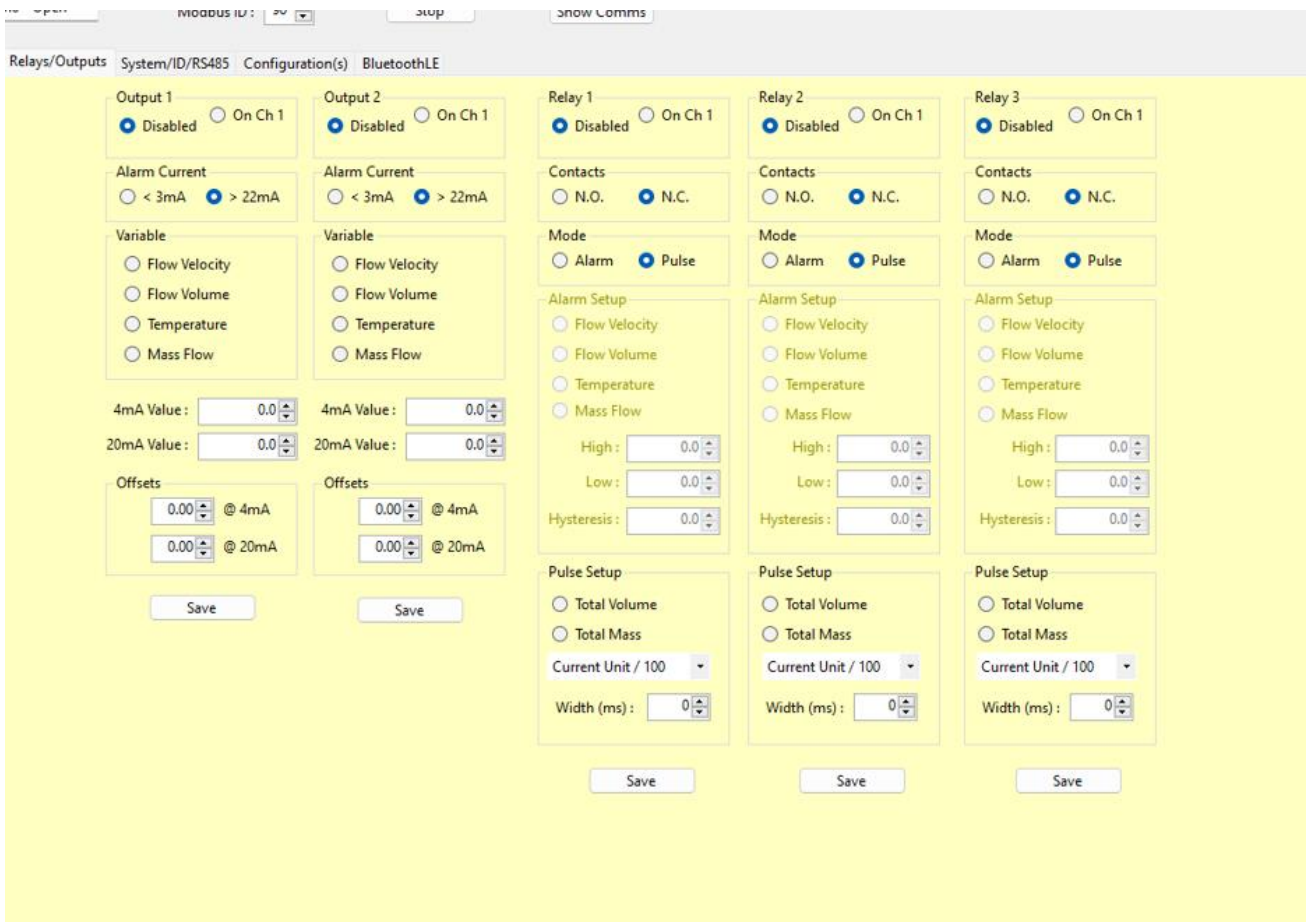

Figure 19: Relays/Outputs tab (for single channel use)

4.9.1 Output Configuration:

Enable or disable Output 1 and Output 2 individually as required.

Each output can be assigned to Channel 1 or Channel 2 for flexibility in signal routing.

4.9.2 Analog Output Specifications:

Each output can represent parameters such as Flow Velocity, Flow Volume, Mass Flow or Temperature. The output signal ranges from 4mA to 20mA, with customizable offset values.

4.9.3 Relay Configuration:

Enable or disable three relays individually.

Each relay can be assigned to Channel 1 or Channel 2.

Relays offer options for Normally Open (N.O.) or Normally Closed (N.C.) contacts.

4.9.4 Relay Operating Modes

Relays can operate in either Alarm mode or Pulse mode.

4.9.5 Alarm Setup

Alarm parameters include High, Low, and Hysteresis values for Flow Velocity, Flow Volume, or Temperature. This allows you to set thresholds for triggering alarms based on specific conditions.

4.9.6 Pulse Setup

Pulse output can be configured for Total Flow or Total Mass measurement. You can select different unit options and pulse width values to suit their measurement requirements.

Output 1/2:

- **Disabled**
Output is inactive.
- **On Channel 1 or On Channel 2**
Output can be configured to be active on either Channel 1 or Channel 2.
- **Alarm Current**
Can be set to either less than 3mA or greater than 22mA.
- **Variable**
Output can represent Flow Velocity, Flow Volume, or Temperature.
- **mA Value**
The output signal ranges from a 4mA value (denoted as X) to a 20mA value (denoted as Y).
- **Offset**
The output signal corresponds to (X) at 4mA and (Y) at 20mA.

Relay 1/2/3:

- **Disabled**
Relay 1/2/3 is inactive.
- **On Channel 1 or On Channel 2**
Relay 1/2/3 can be configured to be active on either Channel 1 or Channel 2.
- **Contacts**
Relay 1/2/3 can have Normally Open (N.O.) or Normally Closed (N.C.) contacts.
- **Mode**
Relay 1/2/3 can operate in Alarm or Pulse mode.
- **Alarm Setup**
Can be configured for Flow Velocity, Flow Volume, Mass Flow or Temperature with High (X), Low (Y), and Hysteresis (Z) parameters.
- **Pulse Setup**
Can be set for Flow Volume or Mass Flow with the following options:
 - Current Unit/100
 - Current Unit/10
 - Current Unit
 - Current Unit*10
 - Current Unit*100
 - Set pulse width (ms)

Once your choice has been selected, remember to press "Save" to apply the changes.

4.10 System/ID/RS485 tab

The screenshot shows a software configuration window with a yellow background. At the top, there are tabs: 'Inputs', 'System/ID/RS485', 'Configuration(s)', and 'BluetoothLE'. The 'System/ID/RS485' tab is active. The window is divided into two main panels. The left panel, titled 'Identification', contains seven dropdown menus, each with the value '0' selected. The fields are: Unit Model, Unit Type, Manufacturer Serial Number, Manufacture Date, Serial Number, Control Firmware Version, Processing Firmware Version, and Hardware Version. A 'Save' button is located at the bottom of this panel. The right panel, titled 'RS485', contains four fields: 'Slave Address' (dropdown with '90'), 'Baud' (text field with '9600'), 'Stop Bits' (text field with '1'), and 'Parity' (text field with 'None'). A 'Save' button is located at the bottom of this panel.

Figure 20: System/ID/RS485 tab

4.10.1 Identification

- **Unit Model**
The specific model name or number of the unit. This helps in identifying the exact type or variant of the unit being used.
- **Unit Type**
A categorization of the unit based on its functionality or application. This designation distinguishes between different types of metering units within a product line.
- **Manufacturer Serial Number**
A unique identification number assigned by the manufacturer to each unit. This serial number is essential for tracking and maintenance purposes.
- **Manufacture Date**
The date when the unit was produced by the manufacturer. This information helps in assessing the age of the unit and planning for maintenance or replacement cycles.
- **Serial Number**
An additional serial number or identifier assigned to the unit instrument user, which may be used for internal tracking or compatibility verification. This Serial number must be given when order is placed.
- **Control Firmware Version**
The version number of the firmware responsible for controlling the operation of the unit. Firmware updates may include bug fixes, performance enhancements, or new features.

- **Processing Firmware Version**

The version number of the firmware responsible for processing data collected by the unit. Updates to this firmware may improve data accuracy, analysis capabilities, or integration with other systems.

- **Hardware Version**

A designation indicating the specific hardware configuration or revision of the unit. Hardware versions may vary based on improvements in components or design changes over time.

4.10.2 RS485

Modbus RS485 is a widely used communication protocol in industrial automation systems. It enables communication between devices over a serial connection, particularly suited for applications requiring reliable data exchange between a master device and multiple slave devices.

Baud Rate (Baud)

The baud rate refers to the rate of transmission in bits per second (bps). It determines the speed at which data is transferred between devices. Common baud rates for Modbus RS485 include 9600, 19200, and 38400 bps, although other speeds are also supported.

Parity

Parity is a form of error-checking used to ensure data integrity during transmission:

- **None**
No parity checking is performed.
- **Even**
The number of transmitted bits set to 1 is maintained as even.
- **Odd**
The number of transmitted bits set to 1 is maintained as odd.

Stop Bits

Stop bits indicate the end of a data frame and help in synchronizing the communication between devices:

- **1 Stop Bit**
One stop bit is transmitted at the end of each data frame.
- **2 Stop Bits**
Two stop bits are transmitted at the end of each data frame, providing more robust synchronization.

Slave Address

In Modbus RS485 communication, each slave device on the network is assigned a unique address to enable the master device to identify and communicate with it. The slave address is typically a

numerical value ranging from 1 to 247, although certain reserved addresses may have specific functions.

Example Configuration:

- Baud Rate: 9600 bps
- Parity: Even
- Stop Bits: 1
- Slave Address: 1

NOTE: ENSURE THAT ALL DEVICES ON THE MODBUS RS485 NETWORK ARE CONFIGURED WITH COMPATIBLE PARAMETERS TO FACILITATE SUCCESSFUL COMMUNICATION. MISCONFIGURATION OF ANY PARAMETER CAN LEAD TO COMMUNICATION ERRORS OR DATA CORRUPTION. ALWAYS REFER TO DEVICE DOCUMENTATION FOR SPECIFIC CONFIGURATION DETAILS AND COMPATIBILITY CONSIDERATIONS.

4.11 Configuration(s)

These setting determine how data is displayed in *Measure* mode.

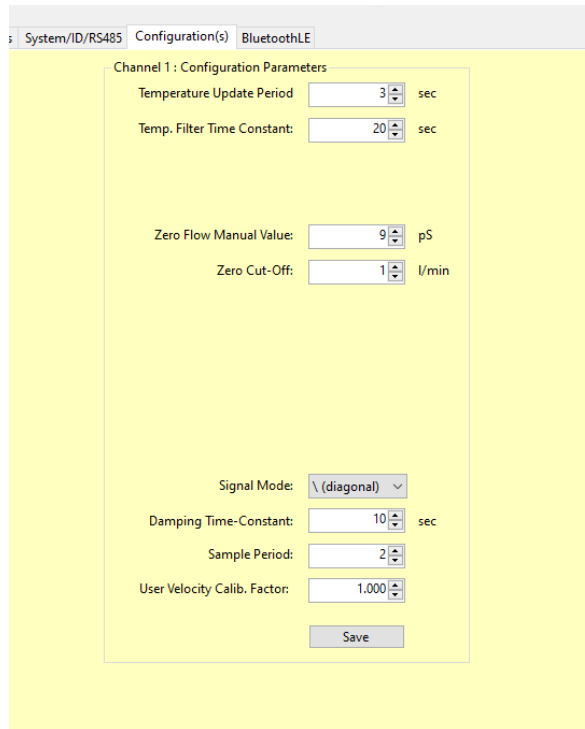

Figure 21: Configuration(s) tab (for single channel use)

- Temperature update period (sec)**
 This refers to the frequency at which the device updates the temperature readings. It determines how often the system checks for changes in temperature.
- Temperature filter time constant (sec)**
 This parameter sets the time constant for the temperature filter. It controls the responsiveness of the temperature readings to changes over time.
- Zero flow manual value (pS)**
 This is a manually inputted value used for zero flow calibration. It serves as a reference point for the system when there is no flow.
- Zero flow cut-off**
 This parameter determines the minimum flow rate below which the device considers it as zero flow. It helps in filtering out noise and maintaining accuracy at low flow rates.
- Signal Mode**
 This is the number of times signal crosses the path it can be diagonal, signal or double.
- Damping time-constant**
 This parameter sets the time constant for the damping filter applied to the signal. It controls the rate at which the system responds to changes in flow rate.

- **Sample period**
This defines the number of times reading is taken.
- **User Velocity Calibration Factor**
This allows application-specific calibration.

Once your choice has been selected, remember to click on **Save** to apply the changes.

4.12 BluetoothLE

This tab is non configurable and simply shows the Bluetooth connection and communications between the Set up programme and the DCSIU. It also flags up if any of the configured values are outside of the limits. For example if any of the values are out of limits it will be seen here. Potentially flagged in Red text.

- Fit the blue cable to D1 (Downstream).
- Fit the red cable to U1 (Upstream).

5.2 Using Transducers in Diagonal Mode

For Diagonal Mode, the transducer guide rails must be fitted on opposite sides of the pipe. It is necessary to accurately mark out the required positions to ensure that the transducers are correctly positioned and aligned along the axis of the pipe, directly opposite each other on a 45° axis with respect to the top of the pipe, and at the required separation.

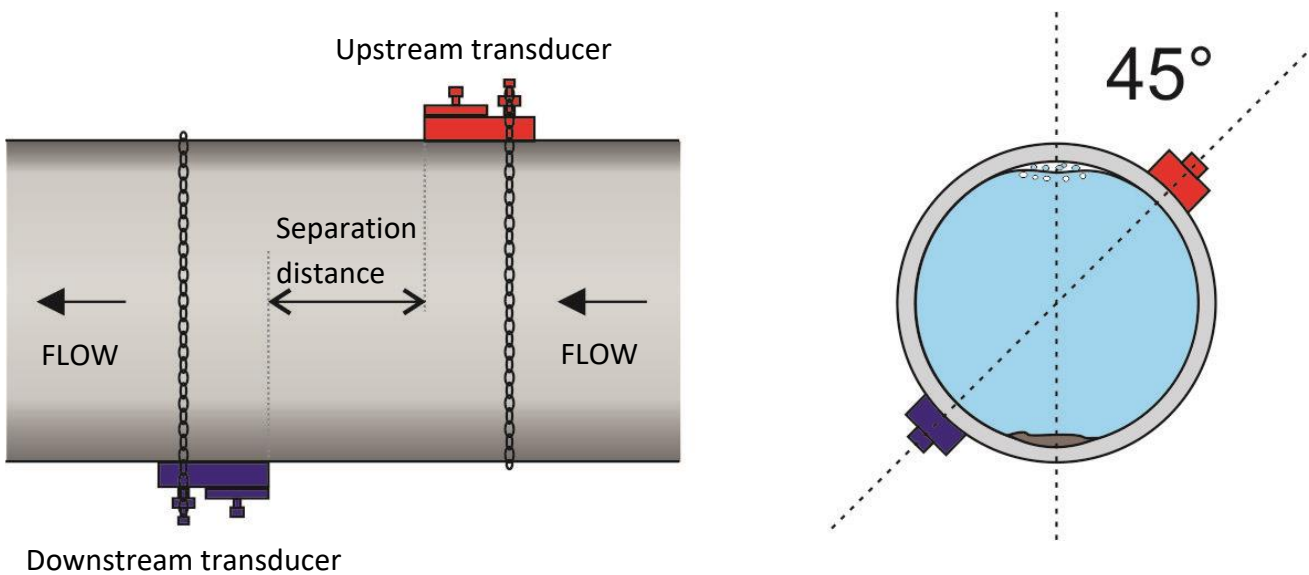

Figure 23: Transducer locations for Diagonal Mode

To position the transducers:

1. Obtain and note the separation distance between the transducers.
2. Mark a reference line around the pipe approximately where the upstream transducer is to be fitted.

An easy way to draw a perpendicular circumference around a large pipe is to wrap a length of material such as chart paper around the pipe, aligning the edges of the paper precisely at the overlap. With the edge of the chart paper being parallel, either edge describes a circumference around the pipe that is perpendicular to the pipe axis.

3. Mark a position on the reference line approximately 45° from the top of the pipe. This is the location for the upstream transducer.
4. From this point, draw a line equal to the separation distance and parallel to the pipe axis in the downstream direction.

5. At this point, draw another line around the circumference of the pipe.
6. Mark the position 180° from the upstream transducer's position. This is the location for the downstream transducer.

If you have used the method described in step 2, mark the chart paper exactly where it overlaps. Then, after removing the paper from the pipe, fold the measured length in half keeping the edges parallel. The fold line now marks a distance exactly HALFWAY around the pipe. Put the paper back on the pipe and use the fold line to mark the opposite side of the pipe.

5.3 Attach the PT100 Probe(s)

The area of pipe where the temperature probes are to be attached must be free of grease and any insulating material. It is recommended that any coating on the pipe is removed so that the probe has the best possible thermal contact with the pipe.

Clamp the probes in position using the supplied stainless-steel cable ties.

6 MEASUREMENT MODE

In Measure mode, the application shows real-time data readings and updates from the DCSIU, including but not limited to:

- Updated readings
- Graphical data
- Live temperature
- Live VS
- Measured Fluid SoS
- Live SQ (Signal Quality)
- Live cumulative total

To return to the Measure mode from Configure mode:

1. Select the **UX5000** tab.
2. In the *Mode* box, select **Measurement**.
3. Click on the **Save** button.

Upon successful completion of the above steps, the tabs at the top of the configuration software interface will reduce to display only the following options:

- UX5000
- BluetoothLE
- Diagnostics 1

- Diagnostics 2
- BluetoothLE

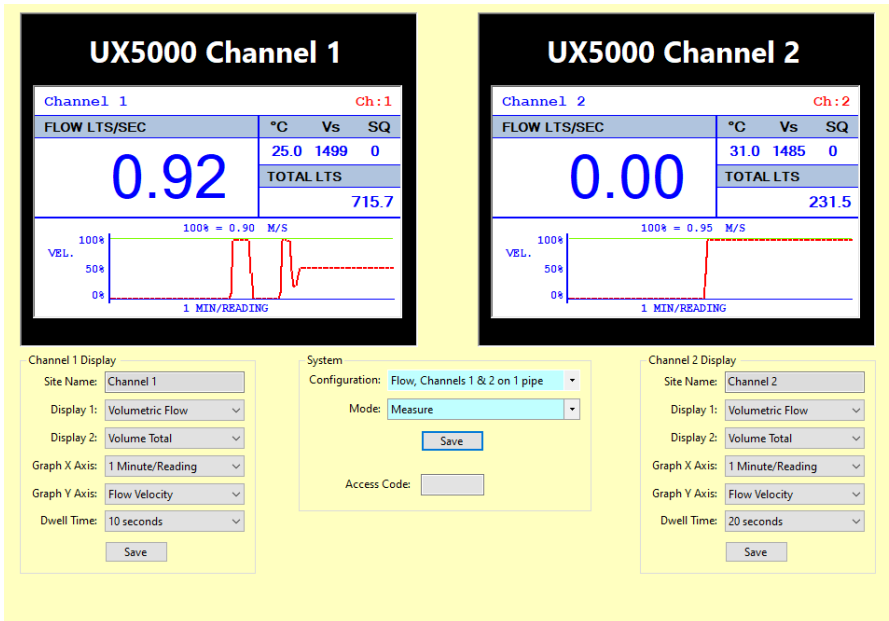

Figure 24: Measure mode (shown for dual channel)

Measurement mode allows the set up of the Display unit from the options given below:

- **Site Name**
 This is a free type area. In the example it is given as Channel 1234. If using 2 channels we recommend that the Site Names are different to ensure easy recognition of which Pipe date is being shown on the display.
- **Display 1**
 This is the large number displayed on the left. In this example 3.28
- **Display 2**
 This is the smaller number displayed on the right, in this example the “Total GAL”
- **Graph X Axis**
 The frequency of the data plot can be selected here. The DCSIU is taking readings over a very short time period. It averages the readings for the time selected and plots the average of the readings taken over the selected time periods. There are 128 data plot points. This gives option of having graphical data shown over a period of 50 days.
- **Graph Y Axis**
 This on a 0 to 100% scale. 100% is the highest reading that has been recorded in time period.
- **Dwell Time**
 Shown if two channels are in use, this is the time that each channel is to be shown on the display, for example: Channel 1 10secs, Channel 2 30 seconds.

7 TROUBLESHOOTING

When the unit has been installed and configured correctly:

- In Measure mode (see Figure 24), the screen displays a flow value with a signal quality of at least 40.
- Check on the **Diagnostics** tab in the *System Diagnostics* group (see page 32) that:
 - Gain is 50dB or lower.
 - Signal-to-noise ratio (SNR) is higher than 20dB.

7.1 No flow reading

A reading of “-----” indicates that there is no usable signal from the flow sensors. It is likely the sensors have been incorrectly fitted. Check the sensor installation steps – refer to Section 2.

7.2 Poor or inconsistent readings

Poor or inconsistent readings can result from a number of causes. Check the following:

7.2.1 Is sensor positioning correct?

For accurate measurements, the sensors must be installed at a position where the fluid flows uniformly (see page 10). Flow profile distortions can result from upstream and to a lesser degree downstream disturbance such as bends, tees, valves, pumps and other similar obstructions. To ensure a uniform flow profile, the unit must be mounted away from any cause of flow disturbance.

7.2.2 Is there air or solids in the liquid/pipe?

If there is an excessive amount of air or solids in the system or if the pipe is empty, the unit will not function correctly (see page 10).

7.2.3 Is there good contact between the sensor and pipe?

Any space between the pipe and sensors will result in a poor signal. Ensure that there is enough ultrasonic grease or that the gel pads are installed on the sensor block in the correct location. Check that the coverings from the gel pads have been removed.

7.2.4 Is the pipe in good condition?

If the pipe’s outer surface is corroded, or there is a possibility of there being deposits on the inside of the pipe, the meter may fail to operate correctly. This will be the result of the roughness of the surface distorting the signals.

7.2.5 Is the pipe galvanised or composite?

If the meter is to be installed on a galvanised pipe it should be noted that the surface roughness can affect the flow accuracy and in some instances the meter will be unable to obtain a valid flow signal.

The UX5000 flow meter has been designed to work on the pipe materials shown in drop down. If other is chosen and readings are problematic please contact our technical team for help. Please note that testing has shown that there is limited compatibility with multi-layer composite pipes. The construction of the pipe doesn't allow signals to propagate correctly.

7.2.6 Is the pipe data entered correctly?

Ensure that the correct inside diameter of the pipe is entered into the configuration (see page 27). This can result in an incorrect sensor separation distance.

7.2.7 Is the fluid a mixture?

The speed of sound varies with fluid composition and temperature, which can lead to a loss of accuracy. A considerable variation in measurements can result from incorrect settings for fluid composition (see page 25).

7.3 Flow reading present when the system is closed

A zero flow offset can be entered on the System Diagnostics tab (see page 32).

7.4 No flow reading visible when the system is active

In installations where there is a low flow rate it will show as the instrument is not reading any flow, this can be remedied by lowering or removing the zero cut-off.

It is worth noting that if the cut-off is lowered beyond the factory setting the unit may show a flow rate on the display when there isn't one due to noise in the system, setting the zero flow can help to alleviate this but noise or temperature instability can affect the reading (see page 32).

7.5 Flow is reversed

The direction of flow is determined when the meter is first powered up from reset and is taken to be the positive flow direction. It is possible this can get set incorrectly if there is back wash or no flow when installing, commissioning or powering up the unit.

If the flow is reversed from that experienced by the meter initially, then the flow rate will still be displayed but the activity indication will change from an asterisk to an exclamation mark. The pulse output is related to the flow in the positive direction, so no pulses will be generated if the flow is reversed. In addition, no totals are accumulated, both volume and energy; and no power is displayed. Communication ports may indicate the flow rate, as this is useful to a remote operator.

7.6 Error and Warning Messages

Error messages are displayed as a number in **Status Channel** on the Diagnostics tab (see page 31). Contact Micronics if other messages are shown.

7.6.1 Error Messages

Error Meaning	Status Byte								Value
	Bit#6-15	Bit#5	Bit#4	Bit#3	Bit#2	Bit#1	Bit#0		
No Signal							1		1
Flow Engine Calculation Error						1			2
Memory comms Error					1				4
Flow Engine Comms Error				1					8
RTD Error			1						16
Configuration Error		1							32
Bits 6-15 Reserved	1								64

8 APPENDIX

8.1 Specification

UX5000	
Accuracy	up to 0.5% with Process Calibration
Repeatability	±0.15%
Fluid Types	All acoustically conductive liquids with <3% Particulate
Pipe Material	Many including Steel, Stainless Steel, Copper, Plastic
Pipe Diameter (OD)	2" to 12" (50-300mm)
Weight (Shipping)	12kg
Dimensions (Shipping Box)	547mm x 397mm x 307mm
DCSIU	
Power	Recommended 21-24 VDC, 2W (Internally protected with 500mA 5x20 Glass Fast Acting Fuse) Max 26VDC
Equipment Group & Category	⊕ II 2 (I) G db [Ex ia] IIC T4 Gb (-20°C≤Ta≤60°C)
Material	Powder Coated Aluminium (Marine Grade)
Weight	2.5kg
Size	206mm x 146mm x 135mm
Operational Temperature	-20 to 60°C
Entries	¾" NPT
Maximum Cable Distance from RMU	50m using extensions & up to 250m using junction boxes
Analogue Outputs (2)	Active 4..20mA
Relay Outputs	3 opto-isolated relay outputs volt free (24V AC or DC at up to 400mA)
RS485 Serial Communications	Modbus RTU
Screen	LCD graphical display
Screen Dimensions	69mm x 50mm
Environmental Protection	IP66 (EN 60529)
Flammability Rating	N/A
Humidity	90% RH at 50°C Max
Indoors / Outdoors	Suitable for use in both
Maximum Altitude	2,000 meters
Pollution degree	4: Continuous conductivity occurs due to conductive dust, rain or other wet conditions
Wet location	Suitable for wet location
RMU	
Environmental Protection	IP66 (EN 60529)
Power	From DCSIU (12V 200mA)
Equipment Group & Category	⊕ II 2 G Ex ia IIC T4 Gb (-20°C≤Ta≤60°C)
Material	Powder Coated Aluminium
Weight	0.6kg

Size	160mm x 100mm x 79mm
Operational Temperature	-20 to 60°C
Temperature Sensor Connections	M8 male waterproof connector
DCSIU Connection	M12 male waterproof connector
Sensor Connections	TNC waterproof connector
Cable Distance from Sensor	5m standard (10m optional)
Flammability Rating	N/A
Humidity	90% RH at 50°C Max
Indoors / Outdoors	Suitable for use in both
Maximum Altitude	2,000 meters
Pollution degree	4: Continuous conductivity occurs due to conductive dust, rain or other wet conditions
Wet location	Suitable for wet location
Sensors	
Environmental Protection	IP66 (EN 60529)
Equipment Group & Category	Ⓔ II 2 G Ex ia IIC T4 Gb (-20°C ≤ Ta ≤ 60°C)
Material	PEEK
Weight	0.2 kg
Size	60mm x 35mm x 30mm
Operational Temperature	-20 to 120°C (T4 ATEX rating T4)
Connection	TNC Waterproof Connector
Connection	Sensors must be connected through the RMU to conform with the certification.
Flammability Rating	UL94V-0
Humidity	90% RH at 50°C Max
Indoors / Outdoors	Suitable for use in both
Maximum Altitude	2,000 meters
Pollution degree	4: Continuous conductivity occurs due to conductive dust, rain or other wet conditions
Wet location	Suitable for wet location
Mounting Fixtures	
DCSIU	Pipe mount on nominal 2" bore pipe or wall mount bracket
RMU	Pipe mount or wall mount bracket
Flow Sensors	Metal guiderail with separation ruler using ultrasonic acoustic gel on the sensors.

8.2 Spares

For replacement parts please see ordering code below. For calibration and/or repair of unit please contact service@micronicsltd.co.uk.

Spares UX5000	Part Number
Temperature Probe kit: Pt100 Temperature Sensor, Stainless Steel Cable Tie, Heat Sink Compound	MC-1T05
Guiderail and Sensor Kit: Guiderail, 2 x Sensors, Superlube rease, 5M Transducer Cables, PT100 Probe, S/S Cable Tie, syringe	MC-1KB05
ATEX Sensor x 2	MC230-5024
Guide rail: Sensor Holders and Ruler	MC-1KGR
Pt100 Temperature Sensor 5M	MC231-5010
Sensor Cable Red 5M	MC194-5019R/5M
Sensor cable Blue 5M	MC194-5019B/5M
Sensor Cable Red 5M	MC194-5019R/10M
Sensor cable Blue 5M	MC194-5019B/10M
Quick Release Clamp 44-559mm	MC225-5008
Quick Release Clamp 52-312mm	MC225-5003
Quick Release Clamp 51- 127mm	MC225-5001
Temperature Heatsink Compound	MC292-0009
Super Lube Grease	MC292-0008
Omega 36 Grease: Food Grade -40 to 200C	MC292-5000
Omega 71 Grease: Universal Non-melt Grease up to 260°C	MC292-0002

8.3 Maintenance and Calibration



DO NOT OPEN THE DCSIU ENCLOSURE IF A FLAMMABLE ATMOSPHERE IS PRESENT.

Maintenance and servicing should only be carried out by Rototherm Engineers. If maintenance of a certified enclosure is required contact Rototherm.

Secure arrangements must be made to ensure that an electrical supply cannot be connected to the circuits feeding into or from the UX5000 during any period when the front cover or electrical entry glands are not fully secured.

IF REPAIR IS REQUIRED IT SHOULD BE CARRIED OUT BY A ROTOTHERM ENGINEER. DO NOT ATTEMPT TO OPEN OR DISMANTLE THE UNIT WHILE THE ELECTRICAL SUPPLY IS CONNECTED.

For calibration, servicing, or repair of the unit please contact: service@micronicsltd.co.uk.



IF REPAIR OR MAINTENANCE IS CARRIED OUT BY OTHER INDIVIDUALS ANY DAMAGE OR DANGER ARISING IS AT THE LIABILITY OF THE USER AND WILL NOT BE COVERED BY WARRANTY.

8.3.1 Periodic Inspection

Periodic inspection of apparatus used in potentially explosive atmospheres should be carried out to ensure that equipment is free from corrosion, damage or contamination that would affect certification.

8.3.2 Sensor Cleaning

To avoid the potential of an electrostatic charging hazard the sensor should only be wiped with a damp anti-static cloth.

8.3.3 Sensor Regreasing

If the sensor grease has dried, then both surfaces must be cleaned thoroughly before refitting as detailed in the installation section. If system performance has degraded and acoustic coupling to the pipe is suspected, the sensors will be removed as part of the inspection. Regrease pads before re-installation.

8.4 Dimensions

8.4.1 General Assembly

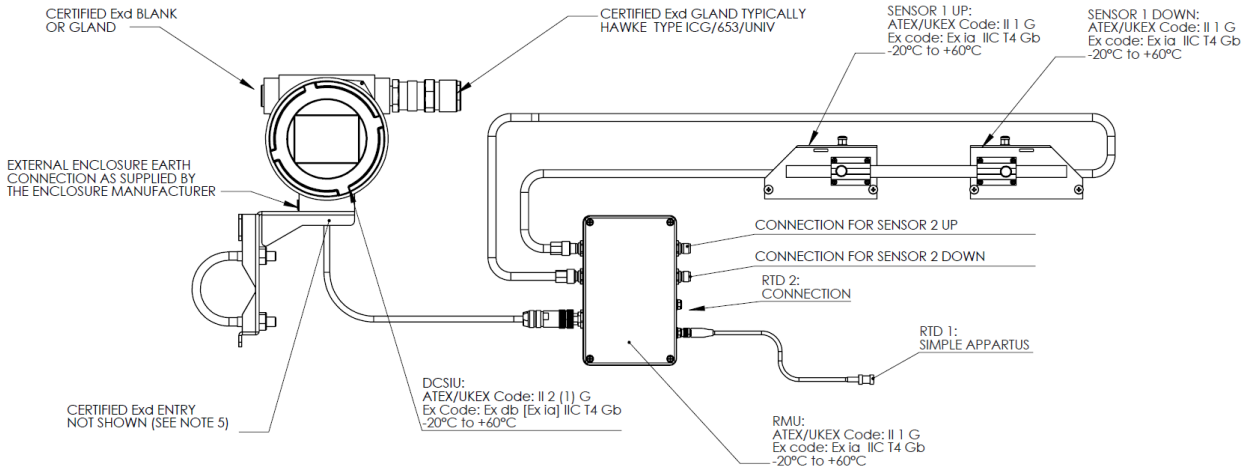

8.4.2 Display Unit (Digital Control and Signal Interface Unit) General Assembly

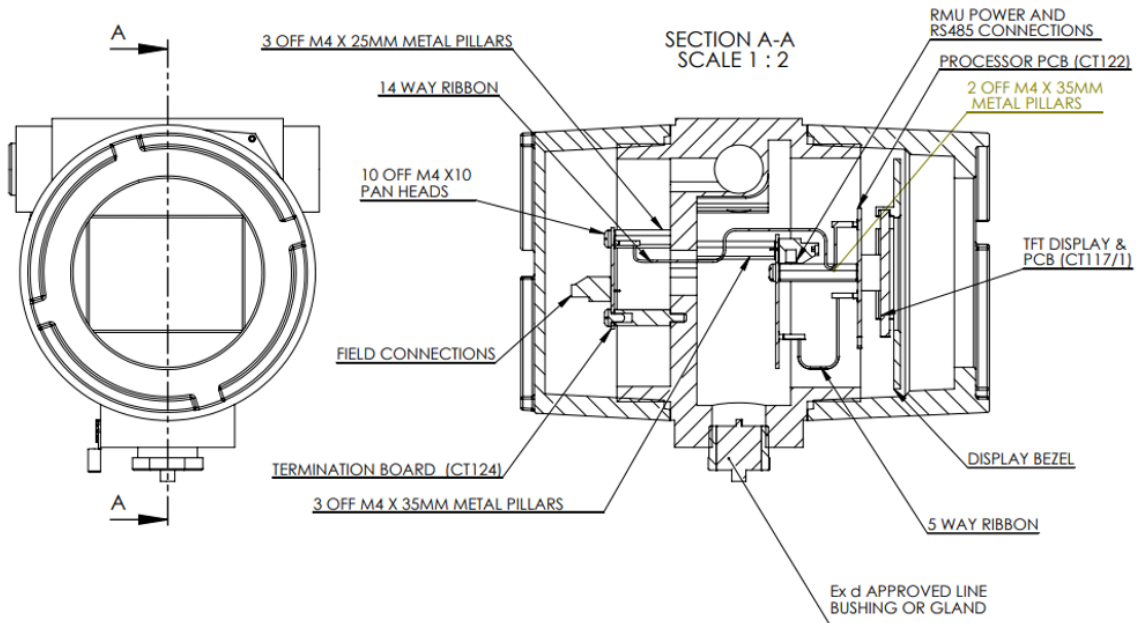

8.4.3 Remote Measurement Unit (RMU) General Assembly

Item	Description	Material
1	Power & RS485	M12 4-pin plug for 12 VDC supply & RS485 coms
2	Down sensor (1)	TNC Socket
3	Up sensor (1)	TNC Socket
4	Down sensor (2)	TNC Socket
5	Up sensor (2)	TNC Socket
6	RTD 2	M8 4 pin socket
7	RTD 1	M8 4 pin socket

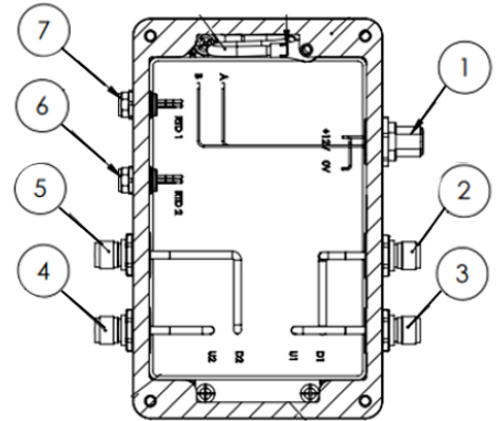
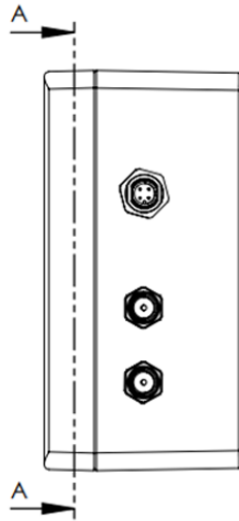

8.4.4 Sensor Guiderail Assembly

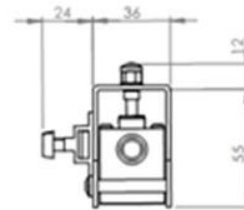
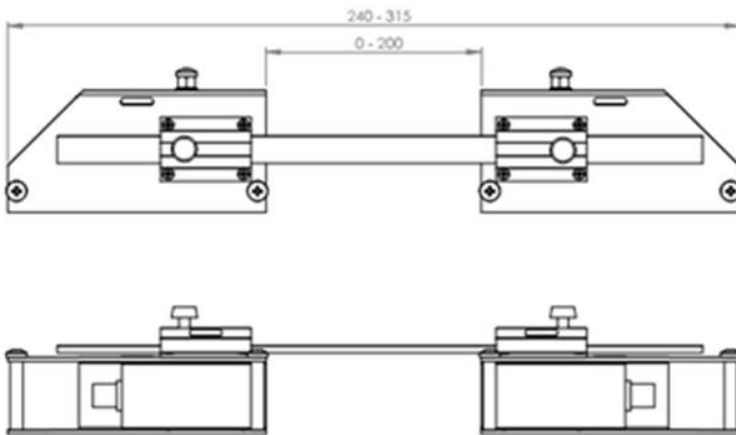

The sensor bracket assembly is configured for reflex (2 path) operation. For direct (1 path) operation the guide rail will not be used.

8.5 Acronym Glossary

DCSIU	Digital Control and Signal Interface Unit
RMU	Remote Measurement Unit
°C	Celsius (Metric Temperature)
mm	Millimetre (Metric Length)
m/s	Metres per second (Metric Flow Velocity)
Kg	Kilogram (Metric Mass)
l/s	Litres per second (Metric Flow Volume)
l/min	Litres per minute (Metric Flow Volume)
m ³ /min	Cubic metres per minute (Metric Flow Volume)
m ³ /hour	Cubic metres per hour (Metric Flow Volume)
l	Litres (Metric Total Volume)
m ³	Cubic metres (Metric Total Volume)
°F	Fahrenheit (Imperial and US Imperial Temperature)
inch	Inch (Imperial and US Imperial Length)
ft/s	Feet per second (Imperial and US Imperial Flow Velocity)
lbs	Pounds (Imperial and US Imperial Mass)
gal/s	Gallons per second (Imperial Flow Volume)
gal/min	Gallons per minute (Imperial Flow Volume)
gal/hour	Gallons per hour (Imperial Flow Volume)
gal	Gallons (Imperial Total Volume)
USgal/s	US Gallons per second (US Imperial Flow Volume)
USgal/min	US Gallons per minute (US Imperial Flow Volume)
USgal/hour	US Gallons per hour (US Imperial Flow Volume)
USgal	US Gallons (US Imperial Total Volume)